

SECRET
SECRET

14-00000 1281D

1034

CORONA J FLIGHT REPORT

FTV 1174 - 35

PREPARED BY

DATE 3/3/69

APPROVED BY

DATE 3/8/69

APPROVED BY

DATE 3-2-69

[REDACTED]
PROGRAM MANAGER

Declassified and Released by the NRO

In Accordance with E. O. 12958

on NOV 26 1997

SECRET
SECRET

~~SECRET~~
~~SECRET~~

LIST OF CONTENTS

SUMMARY

INSTRUMENTATION AND COM A D PERFORMANCE

CAMERA SETTINGS AND FILM TYPES

PANORAMIC CAMERA PERFORMANCE

STELLAR INDEX OPERATION

CLOCK PERFORMANCE

RECOVERY SYSTEM PERFORMANCE

 First Recovery System

 Second Recovery System

REACTIVATION IMAGE PERFORMANCE

INTERNAL CONTROL SYSTEM PERFORMANCE

APPENDICES

~~SECRET~~
~~SECRET~~

SUMMARY

Flight Test Vehicle No. 1174 was a SLV-2A/01A combination, booster and orbital stage launched from Vandenberg Air Force Base at 1:38:24 P.M. PST on 15 February 1964. A dual recovery reconnaissance camera system consisting of panoramic cameras 124 and 125 and stellar index cameras D29/29/29 and D42/42/37 was the primary payload aboard.

Ascent and injection into orbit were normal with the exception of a slow closure of a fuel valve causing a tail off velocity of 27 feet per sec. instead of the predicted 7 feet per sec. This resulted in orbital parameters that were beyond 3 sigma.

Table I is a comparison between the actual and predicted orbital parameters.

TABLE I
ORBITAL PARAMETERS (Orbit 1)

<u>Parameter</u>	<u>Predicted</u>	<u>Actual</u>
Period (Minutes)	90.67	90.92
Apogee (N.M.)	234.65	249.7
Perigee (N.M.)	100.5	99.9
Eccentricity	0.0186	0.0207
Inclination (degrees)	75.0	74.97
Perigee Latitude (degrees)	23	29

A two phase 7 day camera operational mission with no deactive period between phases was programmed. The first phase was completed and a successful air catch recovery of the capsule was made on orbit 49 on 18 February 1964. The second phase of the mission was completed on orbit 112 on 22 February 1964 with a successful air catch recovery of the second capsule.

An evaluation of the payload system operation as derived from telemetry data is included in the following sections of this report.

INSTRUMENTATION AND COMMANDER PERFORMANCE

The instrumentation system performance was satisfactory throughout both phases of the mission.

Several command anomalies occurred during the flight, all at the [REDACTED] Tracking Station during the transmission of AP Analog commands nine (program select) and six (V/H Ramp Level). Command nine anomalies occurred on orbits 7, 22, 29, 39, 55, 70 and 101. A command six anomaly occurred on orbit 102. On all of these passes the command selector either advanced past the desired position or did not advance as commanded. In all cases additional commands were issued to advance the selectors to the desired position prior to fade. The payload system operation or performance was not impaired by these commanding anomalies. However, this problem has occurred on the past several flights and the potential of incorrect program execution exists. Corrective action should be taken at the [REDACTED] Tracking Station as command difficulties are not being experienced at the other tracking stations in the network. This indicates the problem is station peculiar.

CAMERA SETTINGS AND FILM TYPES

Table II is a tabulation of the pertinent camera settings and film types used on this mission.

TABLE II

CAMERA SETTINGS AND FILM TYPES

Panoramic Cameras:	<u>Master</u>	<u>Slave</u>
Film Type	SO-132	SO-132
Slit Width	0.250	0.250
Filter Type	Wratten 21	Wratten 21

Horizon Optics:

	<u>Master</u>		<u>Slave</u>	
	<u>Take-up</u>	<u>Supply</u>	<u>Take-up</u>	<u>Supply</u>
Aperture	F8.0	F6.8	F6.8	F8.0
Exposure Time	1/100 sec.	1/100 sec.	1/100 sec.	1/100 sec.
Filter Type	Wratten 25	Wratten 25	Wratten 25	Wratten 25

Stellar Index

	<u>Stellar Index A</u>		<u>Stellar Index B</u>	
	<u>Stellar</u>	<u>Index</u>	<u>Stellar</u>	<u>Index</u>
Film Type	SO-102	SO-130	SO-102	SO-130
Aperture	F1.8	F4.5	F1.8	F4.5
Exposure Time	2 Sec.	1/500 sec.	2 Sec.	1/500 sec.
Filter Type	None	Wratten 21	None	Wratten 21

PANORAMIC CAMERA PERFORMANCE

Both panoramic cameras operated throughout the mission. Camera operation was monitored on telemetry on 15 passes during the flight. The only dynamic operational anomaly evident was on the first operation after cut and wrap. On this operation (pass 49) the supply idler on the slave camera indicated uneven metering during slowdown at system turnoff. Enclosure 1 is an analog telemetry record showing turnoff during this pass.

A lens stow operation of 4 frames was run on orbit 11 prior to turning on the V/H programmer. Telemetry data indicated both lenses stowed with a cycle period of approximately 8 seconds per cycle.

The cut and wrap operation appeared normal with both lenses stopping in the home or stowed position. All switchover functions occurred as programmed.

Variations of the cycle period repeatability were evident throughout the mission with maximum errors of 4.4 and 4.2 percent for the master and slave instruments respectively. These errors are very similar to the errors noted during pre-flight testing of this system. A tabulation of the cycle period data and the percent error from the programmed cycle periods are included in Table III.

TABLE III
CYCLE PERIOD DATA

<u>Orbit</u>	<u>Time Up Ramp</u>	<u>Master</u>			<u>Slave</u>		
		<u>Nominal</u>	<u>Actual</u>	<u>Percent Error</u>	<u>Nominal</u>	<u>Actual</u>	<u>Percent Error</u>
1	1900	2.500	2.480	0.80	2.517	2.500	0.68
9	650	5.930	6.012	1.4	5.971	6.045	1.25
11	0	7.930	8.080	1.89	8.000	8.350	4.37
25	685	5.778	5.888	1.9	5.817	5.936	2.04
31	2290	2.267	2.293	1.1	2.284	2.317	1.4
33	2475	2.260	2.330	3.1	2.277	2.365	3.86
41	735	5.563	5.491	1.3	5.600	5.584	0.3
47	2365	2.256	2.300	1.95	2.273	2.286	0.57
49	2525	2.269	2.325	2.47	2.286	2.350	2.8
57	1425	3.337	3.420	2.49	3.354	3.470	3.46
61	2300	2.264	2.310	2.03	2.281	2.330	2.1
78	2350	2.257	2.305	2.12	2.274	2.335	2.68
94	2500	2.264	2.335	3.1	2.281	2.355	3.2
104	950	4.711	4.730	0.44	4.739	4.810	1.5

The overall film consumption indicated the camera system was running approximately 1% slow. The V/I ramp level was changed after orbit 94 to increase the cycle rates.

No other dynamic problems were evident in the telemetry data.

Reportedly, the processed film indicated the master camera was slow in coming up to speed on passes after orbit 72. Telemetry data for the engineering passes was reviewed. Both the master and slave turn on characteristics were very similar, with the slave instrument being approximately 1% slower than the master instrument over the entire operation on all engineering passes. The slow turn on of the master instrument was not evident in any engineering pass data for either phase of the mission.

STELLAR INDEX OPERATION

Stellar index operation appeared satisfactory during both phases of the mission. Stellar index operations were monitored on orbits 1, 9, 25, 31, 33, 41, and 47 on the first phase of the mission and on orbits 49, 57, 61, 78, 94, and 104 on the second phase of the mission. All shutter opening and metering functions appeared normal for both stellar index cameras.

CLOCK PERFORMANCE

Clock operation appeared normal with the time accuracy within the reading accuracy of the analog records used for correlation.

RECOVERY SYSTEM PERFORMANCE

First Recovery System:

A successful air catch of the capsule was made on orbit 49. The point of impact was approximately 85 miles downrange and 25 miles east of the predicted impact point. Analysis of the telemetry data indicates no apparent anomalies that would have caused this dispersion. All capsule re-entry

events occurred within tolerance and receiver signal strength data indicates clean separation, spin, and retro events. Vehicle attitude data indicates correct attitude at separation and the re-entry trajectories have been reviewed. Further analysis is continuing.

The condition of the recovered capsule was satisfactory with damage limited to normal paint blistering. Enclosures 2, 3 and 4 are diagrams showing re-entry temperatures. Post flight inspection and testing revealed no anomalies.

Capsule telemetry was acquired at both the [redacted] and [redacted] tracking stations with good coverage of the retro events by both stations. Table IV is a tabulation of the sequence of re-entry and recovery event times.

TABLE IV
RECOVERY SEQUENCE OF EVENTS

<u>Event</u>	<u>System Time</u>	<u>Delta Time</u>	
		<u>Actual</u>	<u>Nominal</u>
Transfer	85777.40		
Elect. Disc.	85778.31	.91	.90 ± .430 .400
Separation	85779.40	2.0*	2.0 ± .25
Spin	85781.53	3.25**	3.4 ± .30
Retro	85789.02	7.49	7.55 ± .45
De-spin	85799.91	10.89	10.75 ± .54
T/C Separation	85801.41	1.50	1.5 ± .15
"G" Switch Open	86307.23	-	-
Parachute Cover Off	86340.06	32.83	34.0 ± 1.5
Drogue Para. Deployed	86340.77	0.71	0.75 ± .08
Drogue Para. Released	86351.35	10.58	10.05 ± 1.0
Main Para. Deployed	86352.16	0.81	1.2 ± .15
Main Para. Disreefed	86356.27	4.11	4.0 ± 1.7

* From Transfer

** From Electrical Disconnect

Spin Rate	66.2 RPM
De-spin Rate	3.4 RPM (Data Questionable)
Retro Velocity	950 FPS
Recovery Battery Voltage at Arm	14.5 Volts

Second Recovery System:

The temperature sensor installed on the dreamboat battery indicated a temperature of approximately 60 degrees (enclosure 11) prior to actuation of the battery heaters at first recovery on orbit 49. At the next real-time acquisition (orbit 56) this sensor indicated 104 degrees. The temperature stabilized at 100 to 104 degrees for the remainder of the flight as indicated by this monitor. Temperature data was recorded for approximately one-half an orbit for orbits 50, 51, 52, and 53. These data have been plotted and are included as Enclosure 5. They indicate a constant increase in temperature until stabilization near the end of orbit 53 with no fluctuations indicative of thermostatic action. Tape recorded data on these and other orbits indicated self-heating of the temperature sensor of about 4 to 8 degrees. This has not been subtracted from the above data or from data plotted in Enclosure 5.

From an evaluation of the data, it appears that the battery temperature did not actually reach the 95 degrees required for the thermostat to shut off the heaters. An analysis indicates that by subtracting the observed self-heating and by applying any other instrumentation tolerances

coupled with the low internal system temperatures, the required 95 degree temperature was not reached.

Post-flight testing of the battery indicated proper thermostat action with turn on at 65 degrees and turn off at 95 degrees. A post-flight calibration of the temperature sensor was made and compared favorable to the calibration used in flight. See Enclosure 6.

A successful air catch recovery of the capsule was made on orbit 112. The impact point was within the tolerances of impact prediction.

Telemetry data for the retro events acquired at [REDACTED] was noisy and events prior to retro were not monitored. Retro, de-spin and thrust cone separation appeared normal. Telemetry data for the parachute deployment events indicated normal deployment. Table V is a tabulation of the recovery event times.

TABLE V
RECOVERY SEQUENCE OF EVENTS

<u>Event</u>	<u>System Time</u>	<u>Delta Time</u>	
		<u>Actual</u>	<u>Nominal</u>
Retro	83410.5 ± 0.1	-	-
De-Spin	83421.4 ± 0.1	10.90	10.75 ± .54
M/C Separation	83422.2 ± 0.1	0.80	1.5 ± .15
"G" Switch Open	83934.00	-	-
Parachute Cover Off	83967.62	33.62	34.0 ± 1.5
Drogue Parachute Deployed	83968.22	0.60	0.75 ± .08
Drogue Parachute Release	83977.86	9.64	10.05 ± 1.0
Main Parachute Deployed	83978.67	0.79	1.2 ± .15
Main Parachute Disreefed	83983.28	4.61	4.0 ± 1.7
Spin Rate	66.6 RPM		

The physical condition of the recovered capsule was satisfactory. However, minor scratches were evident directly below the normal resting position of the capsule on the forebody forward guides.

Enclosures 7, 8 and 9 are diagrams showing re-entry temperatures encountered.

REACTIVATION PHASE PERFORMANCE

Deactivation was commanded on orbit 112 at the [redacted] Tracking Station after second recovery. The vehicle was inactive until orbit 269. Reactivation was commanded on orbit 269 and was successfully achieved. Battery power was marginal and was not sufficient to permit restabilization. The payload system was programmed to operate on orbit 277; however, the batteries were depleted approximately 20 seconds prior to this operation.

THERMAL CONTROL SYSTEM PERFORMANCE

The space structure for Flt. 1174 (J-5) was painted to provide critical camera subsystem component temperatures according to the requirements of SP2-478, "J Program Requirement Specifications".

The J-5 paint pattern was based upon preliminary parametric thermal analyses conducted by LMSC utilizing an incomplete thermal model of the physical system and flight data observed during M-25, M-26 and J-2 Missions.

The basic external thermal control surfaces were silicone silastic and vapor deposited gold as shown:

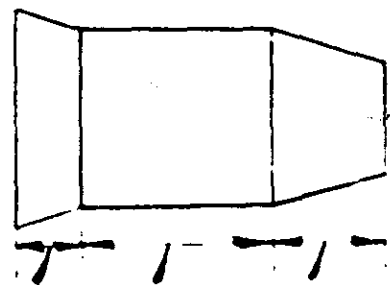

34	34	-2%	Silicone Silastic
66%	66	58%	Gold

The exception to the above pattern was in the area of the index camera where a larger percentage of black paint was used on this vehicle than on previous vehicles.

The external cover surfaces, where feasible, of both S/I's were covered with Mystic tape in order to increase the S/I temperature related to data taken on the previously-mentioned missions.

The design for this vehicle was based upon an initial B range of -46° to -32°.

A system of temperature sensor identification is used throughout this report which incorporates abbreviations. The general identification form is:

X - A - Y

where:

X defines the first or second system number, as the case may be,

A defines the system

Y defines the temperature sensor number

i.e.

2 I - 4 is the No. 2 instrument temperature sensor 4

1 B - 5 is No. 1 barrel temperature sensor 5

The following abbreviations for A were used:

- F - Fairing
- B - Barrel
- CL - Clock
- C - Take-Up Cassette
- AI - Agena Interface
- SC - Supply Cassette
- I - Instrument
- S/I - Stellar Index Camera
- TC - Thrust Cone
- BAT - Dreamboat Battery (Recovery Battery)

A tabulation of the real-time temperature data acquired at the [REDACTED] Tracking Station is included as Enclosures 10 and 11.

The Appendix contains tape recorded thermal data for orbits 0, 1, 22, 39, 72, 85 and 101. The orbital 4th power average values for the skin sensors and the instrument sensors were used as input to a computer program which calculates the orbital station average skin temperature (\bar{T}) and computes an indicated temperature gradient across the inside of the barrel. The results of these computations are presented in Enclosure 21, which is a plot of skin station \bar{T} , barrel center average temperature, (T_{1c}) minimum and maximum internal temperatures vs. orbit number. Enclosure 22 is a plot of sun angle (β) vs. orbit number. Enclosure 23 is a cross plot of skin \bar{T} and T_{1c} vs. β .

~~SECRET~~
~~SECRET~~

These data have been corrected for self-heating per empirical data derived from a special self-heating test conducted in pre-flight environmental testing and confirmed by orbital tape recorded data. The micro system transducer self-heating curve was obtained in laboratory testing and is presented as Enclosure 12. The self-heating testing for BN 2400 transducers consisted of soaking the payload system for approximately 12 hours at ambient temperature and simulated altitude without excitation voltage on the temperature transducers. Telemetry recorders were turned on simultaneously with the excitation voltage and the temperature data was monitored for 90 minutes. These data are presented in Enclosure 13. The self-heating curves obtained in this testing were compared with on-orbit tape recorded data for one complete orbit, orbit 23, and found to be identical with the exception of the thrust cone, dreamboat battery, supply spool, cassette, and camera No. 2 - I 9 sensors. Curves for these sensors have been adjusted accordingly.

It is felt that the temperature data for J-5 is the most accurate thermal data presented to date. The J-5 self-heating test provided individual sensor self-heating corrections based upon installed configuration under simulated orbital conditions. Analysis of apparent self-heating characteristics as demonstrated in flight confirmed the self-heating curves. Analysis of the final tape recorded data presented in this report confirm the accuracy of the self-heating curves. The presented data indicate no significant temperature change at the same latitude on successive orbits; i.e., compare the

~~SECRET~~
~~SECRET~~

first and second to last points presented for each parameter. These data were corrected for self-heating as a function of time from instrumentation on command. Any error in the correction curve will manifest itself as a difference between the two points noted. Furthermore, compare the 4th power averages of all instrument sensors; they appear reasonably close to one another. The computer routine used to calculate the apparent thermal gradient across the inside of the barrel assumes the internal mass to be a thermally homogeneous slug. The standard deviations of the curve fits to the instrument sensor data were, on the average, approximately 3.6°F . This standard deviation is considered well within the expected values considering the inaccuracies of the basic assumptions. Again this relationship lends credence to the relative accuracy of the individual instrument sensor calibrations.

The advent of self-heating corrections has caused some confusion to those not intimately involved in the processing of thermal data. For this reason, the following history of self-heating correction application is presented:

Prior to J-1	Self-heating unknown - no correction applied.
J-1	Eias of 10°F to instrument sensors only.
J-2	Use of a single time function curve based on lab test. Curve asymptotic at 14°F .
M-25, M-26	Use of a single time function curve based on analysis of orbital tape recorded data. Curve asymptotic at 6°F .

J-5

Use of individual sensor time function curve based upon vehicle environmental test and confirmed by analysis of orbital tape recorded data. Curves varied in asymptote from 29^oF to 4^oF. The bulk of instrument sensors corrected by use of curve asymptotic at 12^oF.

There was no significant overall system temperature error for the payloads for which corrections were applied; however, significant errors for individual sensors did exist prior to J-5. Prior to J-1, the tape recorder was not used and the instrumentation was on for short times when data points were hand reduced and presented in the flight reports. Except for TS-11, the self-heating errors prior to J-1 were probably not significant.

On the basis of these data, it is felt that the self-heating corrections applied to the temperature data is accurate within ± 3 degrees.

Calibration Curves were made for each individual temperature sensor using measured divider and sensor resistance values wherever possible.

Enclosures 14 through 20 show the temperature sensor locations for the system.

The following temperature sensors are switched at the time of first recovery:

~~SECRET~~
~~SECRET~~

1. First recovery system thrust cone to second recovery system thrust cone.
2. Stellar index No. 1 to stellar index No. 2.
3. Fairing sensors to barrel No. 1 sensors.

~~SECRET~~

SECRET

GASSETTE ROTATION

1174-35 ARBIT

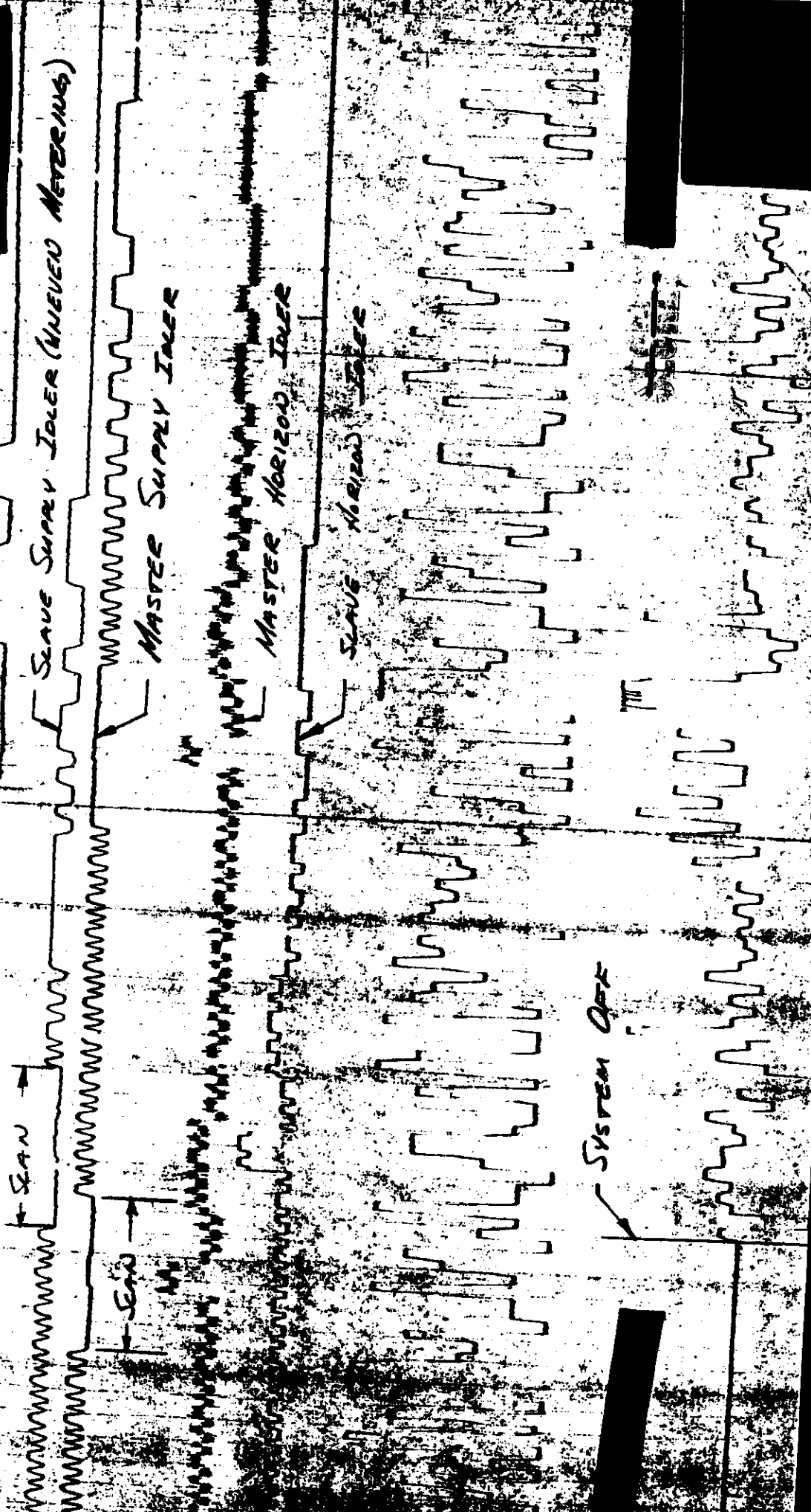

~~SECRET~~

-Z

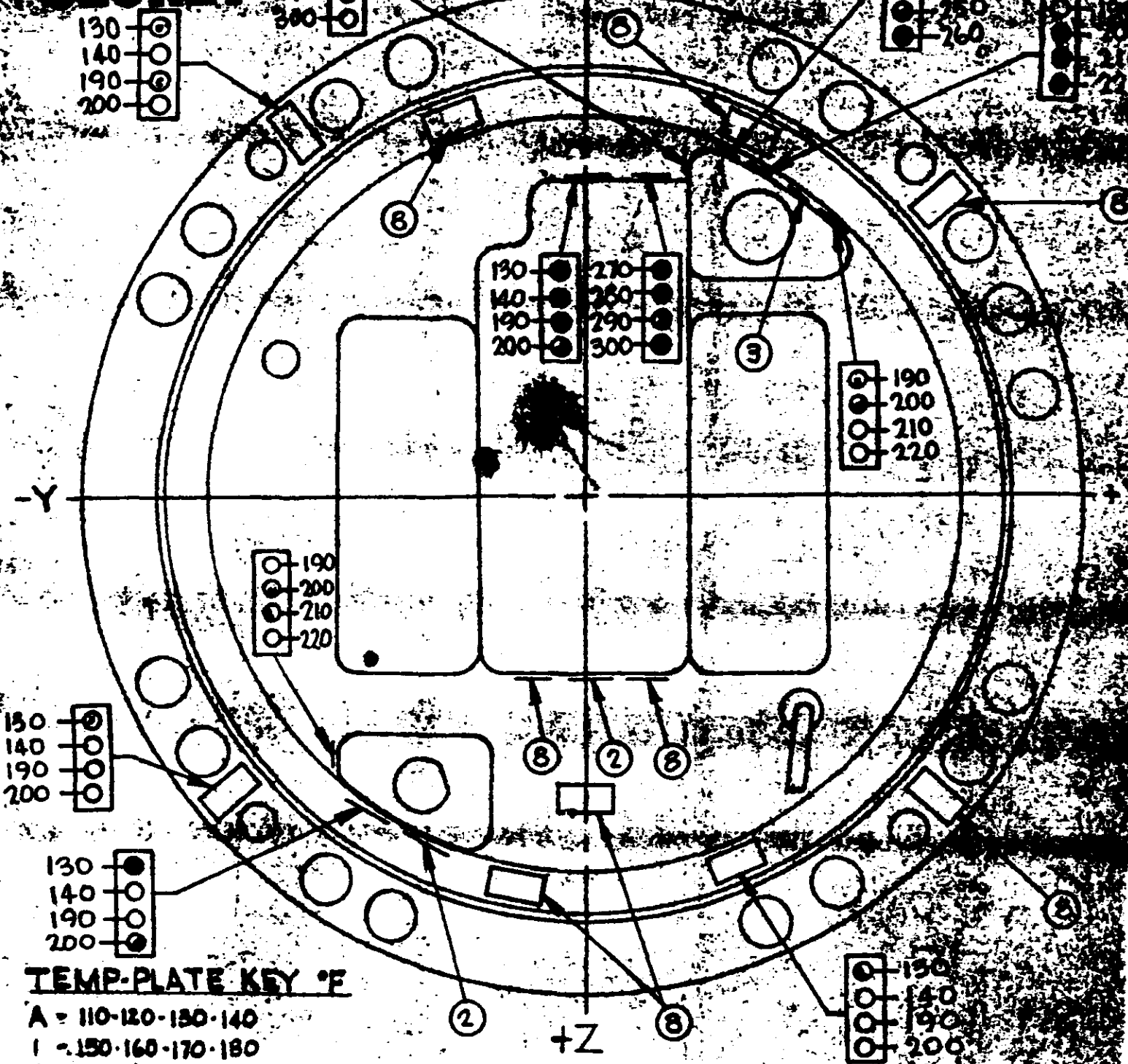

TEMP-PLATE KEY °F

- A - 110-120-130-140
- 1 - 150-160-170-180
- 2 - 190-200-210-220
- 3 - 230-240-250-260
- 4 - 270-280-290-300
- 5 - 310-320-330-340
- 6 - 350-360-370-380
- 7 - 390-410-435-450
- 8 - 130 140 190 200

LOOKING FORWARD
VEHICLE 1174

● INDICATOR TURNED BLACK
TEMP REACHED OR EXCEEDED
INDICATED LEVEL

J5 A

~~SECRET~~

ENCLOSURE 2

~~SECRET~~

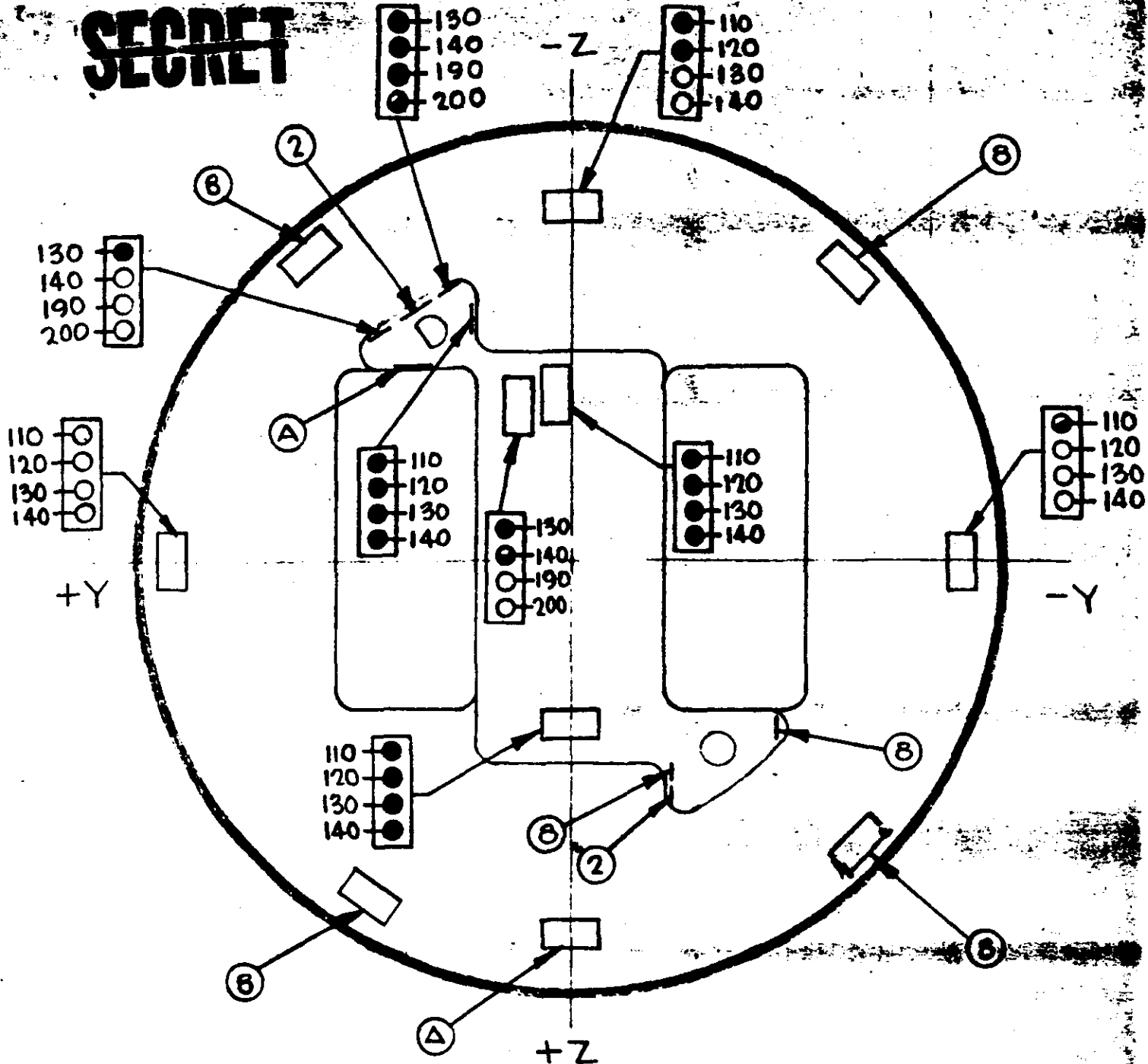

LOOKING AFT
 VEHICLE 1174
 USE OF TEMP-PLATES)

TEMP-PLATE KEY °F

- A- 110 · 120 · 130 · 140
- 1- 150 · 160 · 170 · 180
- 2- 190 · 200 · 210 · 220
- 3- 230 · 240 · 250 · 260
- 4- 270 · 280 · 290 · 300
- 5- 310 · 320 · 330 · 340
- 6- 350 · 360 · 370 · 380
- 7- 390 · 410 · 435 · 450
- 8- 130 · 140 · 190 · 200

● INDICATOR TURNED BLACK
 TEMP REACHED OR EXCEEDED
 INDICATED LEVEL

J5 Δ

~~SECRET~~

ENCLOSURE 3

-Z **SECRET**

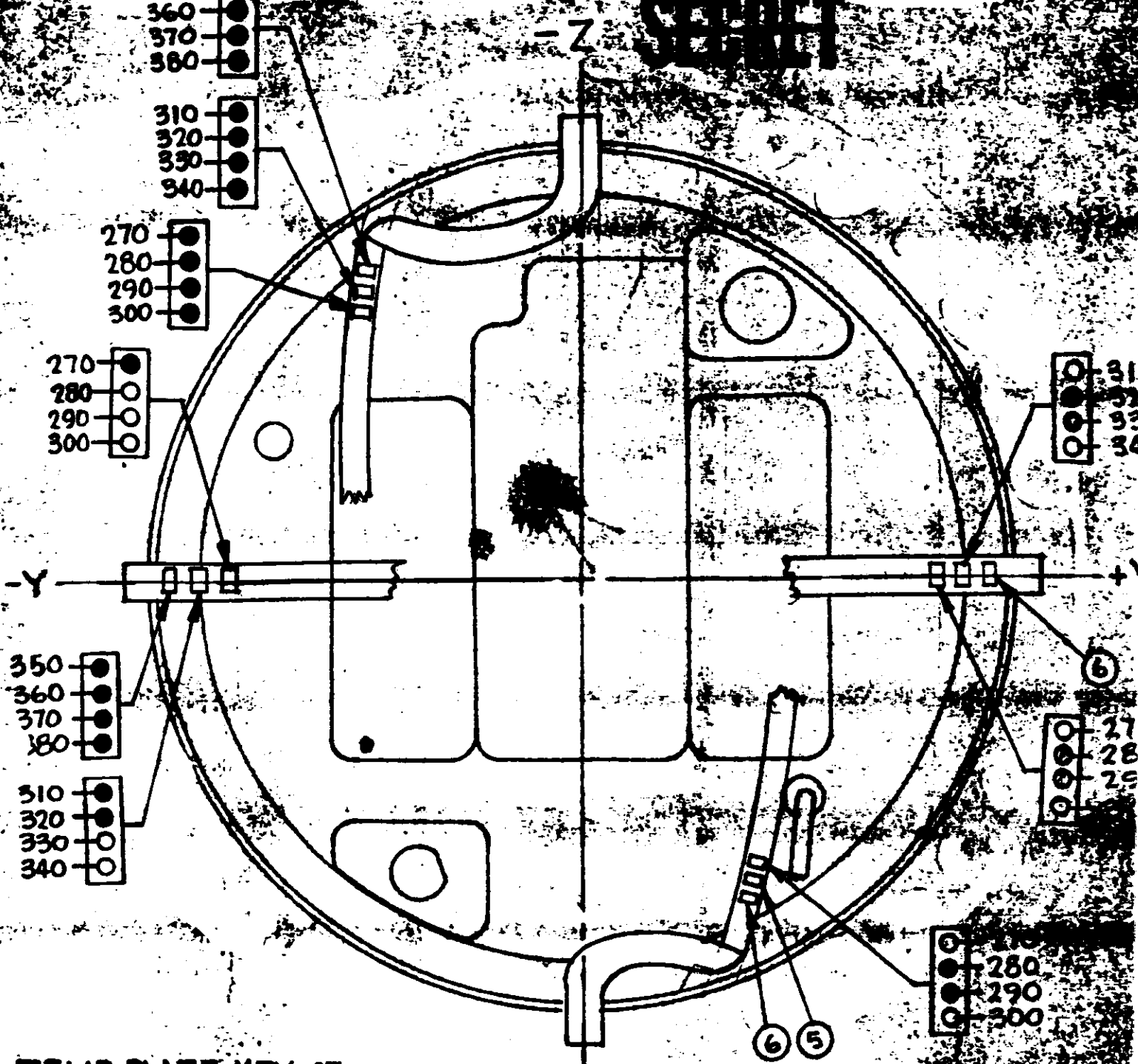

TEMP-PLATE KEY °F

- A - 110-120-130-140
- 1 - 150-160-170-180
- 2 - 190-200-210-220
- 3 - 230-240-250-260
- 4 - 270-280-290-300
- 5 - 310-320-330-340
- 6 - 350-360-370-380
- 7 - 390-410-435-450

LOOKING FORWARD
 VEHICLE 1174
 USE OF TEMP PLATES
 ON PARACHUTE SHROUDS.

● INDICATOR TURNED BLACK
 TEMP REACHED OR EXCEEDED
 INDICATED LEVEL

J5A

SECRET

ENCLOSURE 4

117A - FS REQUIRED SYSTEM
OPERATIONAL CRITERIA
TEMPERATURE

TAPE REQUIRED DATA
NO SELF HEATING OF TAPS

TEMPERATURE (DEGREES)

140

120

100

5

105
100

100
95

95
90

90
85

85
80

80
75

75
70

70
65

15

15

15

15

SYSTEM TIME (HOURS OF STORAGE)

SECRET

SECRET

1-5 1174 DRENNON ROAD BUTTE, MONT. 59701
1-6 1174 DRENNON ROAD BUTTE, MONT. 59701
(NO SELF REPORTING OBSERVATIONS)

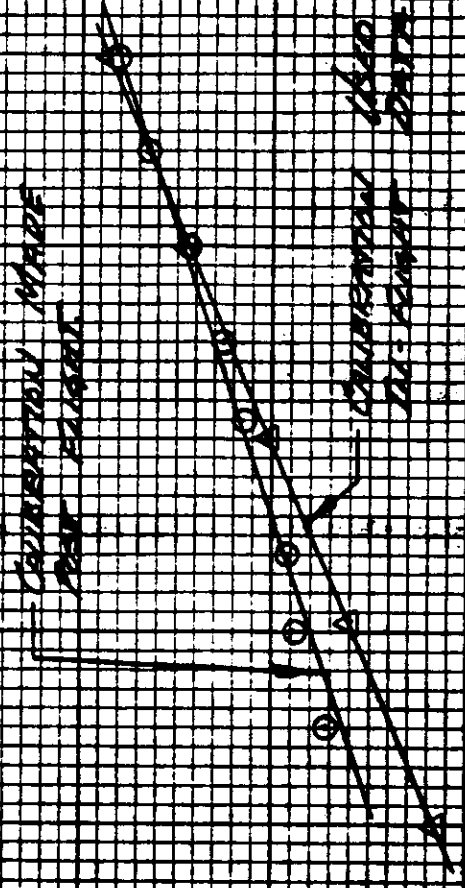

1-5 1174 DRENNON ROAD BUTTE, MONT. 59701
1-6 1174 DRENNON ROAD BUTTE, MONT. 59701
(NO SELF REPORTING OBSERVATIONS)

1-5 1174 DRENNON ROAD BUTTE, MONT. 59701
1-6 1174 DRENNON ROAD BUTTE, MONT. 59701
(NO SELF REPORTING OBSERVATIONS)

1-5 1174 DRENNON ROAD BUTTE, MONT. 59701
1-6 1174 DRENNON ROAD BUTTE, MONT. 59701
(NO SELF REPORTING OBSERVATIONS)

1-5 1174 DRENNON ROAD BUTTE, MONT. 59701
1-6 1174 DRENNON ROAD BUTTE, MONT. 59701
(NO SELF REPORTING OBSERVATIONS)

SECRET
SECRET

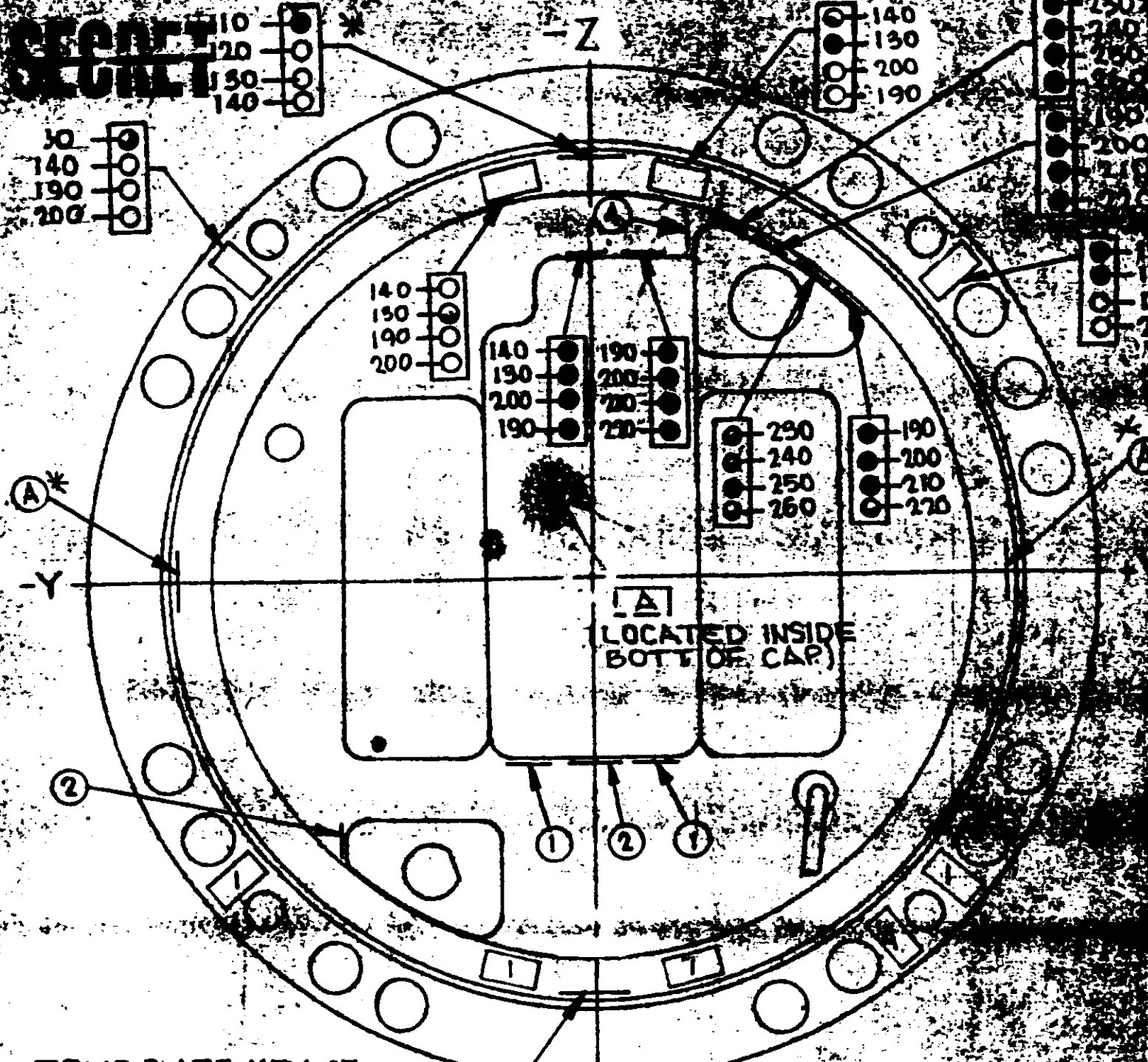

TEMP-PLATE KEY °F

- A - 110-120-130-140
- 1 - 130-140-190-200
- 2 - 190-200-210-220
- 3 - 230-240-250-260
- 4 - 270-280-290-300

* (A) +Z

**LOOKING FORWARD
VEHICLE 1174**

* (A) LOCATED INSIDE CAPSULE ON NOSE WALL

● INDICATOR TURNED BLACK
TEMP REACHED OR EXCEEDED
INDICATED LEVEL

J5 B

SECRET

ENCLOSURE 7

~~SECRET~~
~~SECRET~~

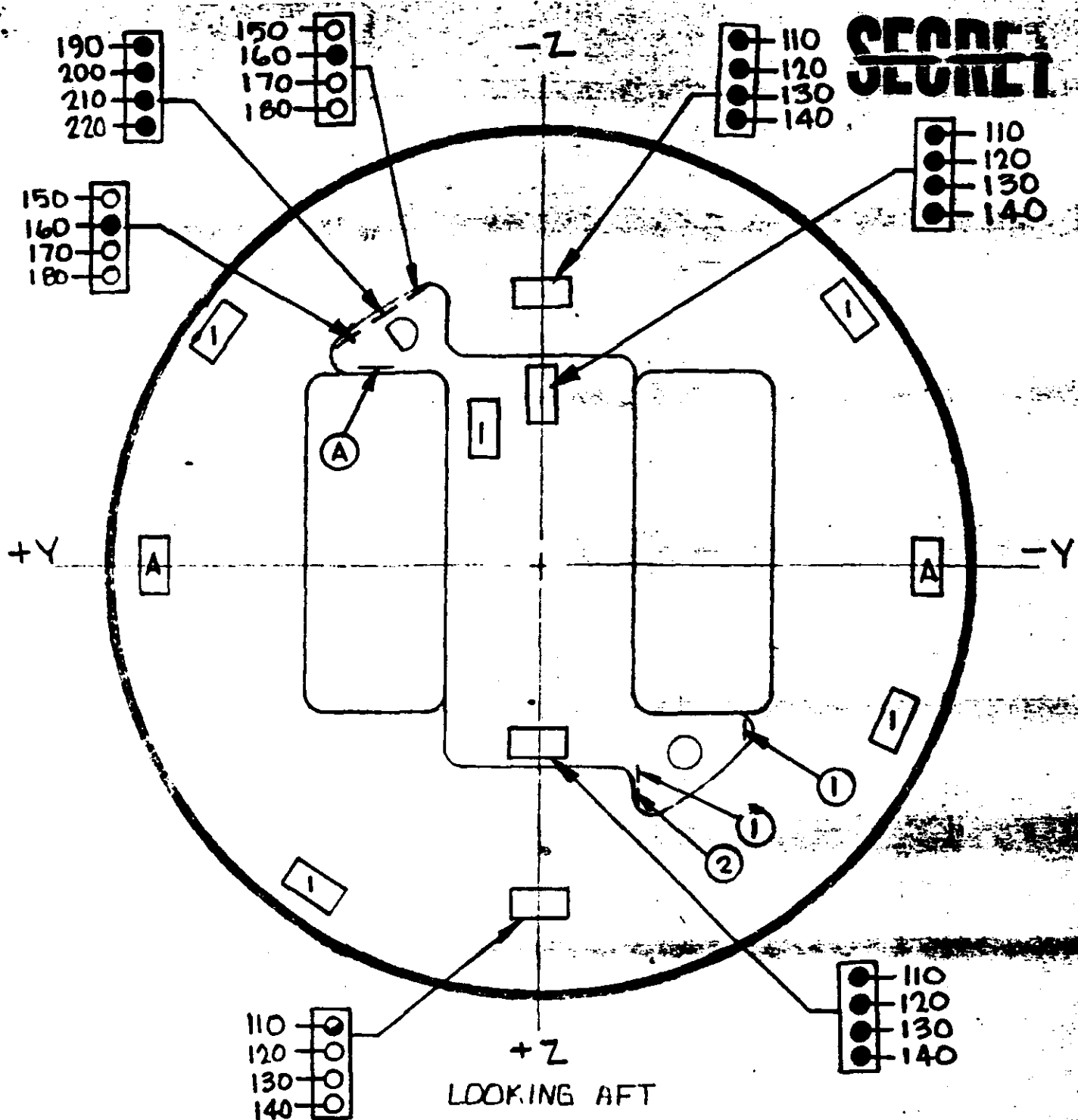

LOOKING AFT
 VEHICLE 1174
 USE OF TEMP-PLATES)

TEMP-PLATE KEY °F

- A- 110 · 120 · 130 · 140
- 1- 150 · 160 · 170 · 180
- 2- 190 · 200 · 210 · 220
- 3- 230 · 240 · 250 · 260
- 4- 270 · 280 · 290 · 300
- 5- 310 · 320 · 330 · 340
- 6- 350 · 360 · 370 · 380
- 7- 390 · 410 · 435 · 450

● INDICATOR TURNED BLACK
 TEMP REACHED OR EXCEEDED
 INDICATED LEVEL

~~SECRET~~

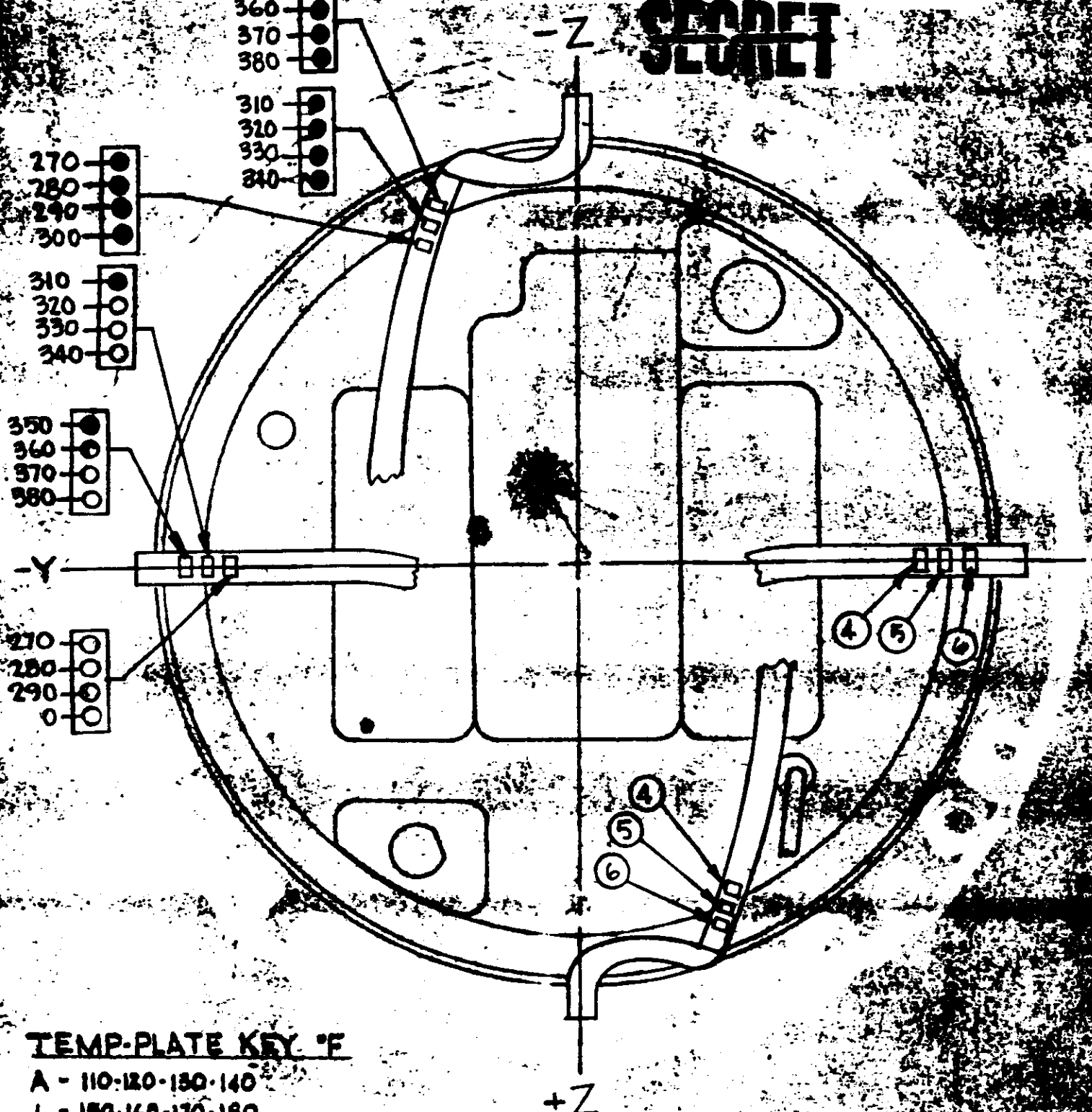

TEMP-PLATE KEY °F

- A - 110-120-130-140
- 1 - 150-160-170-180
- 2 - 190-200-210-220
- 3 - 230-240-250-260
- 4 - 270-280-290-300
- 5 - 310-320-330-340
- 6 - 350-360-370-380
- 7 - 390-410-435-450

LOOKING FORWARD
 VEHICLE 1174
 USE OF TEMP-PLATES
 ON PARACHUTE SHROUDS

● INDICATOR TURNED BLACK
 TEMP REACHED OR EXCEEDED
 INDICATED LEVEL.

J5 B

~~SECRET~~

ENCLOSURE 9.

SECRET
SECRET

J-5 1174 TEMPERATURE SUMMARY

SENSOR

<u>Master</u>	<u>ORBIT</u>	110	104	94	88	78	72	63	56	49	47	41	31	25	16	9	1
3	38	28	36	31	34	33	36	34	38	37	37	42	38	43	41	46	60
4	42	31	39	34	38	35	41	36	42	38	38	44	40	45	42	48	61
5	50	39	46	42	45	44	48	44	50	47	46	54	49	54	52	58	60
6	57	44	53	47	52	51	54	52	57	56	56	62	54	63	60	69	58
7	54	43	51	46	52	49	51	50	54	52	54	58	54	60	58	65	62
8	61	39	47	42	47	44	50	45	61	57	49	55	49	55	52	60	58
9	61	47	32	48	51	51	59	54	61	55	54	63	56	66	61	68	58
10	54	43	32	46	52	49	52	49	54	52	56	58	56	60	58	63	60
11	47	43	51	46	52	49	46	50	47	52	47	51	52	60	46	61	74
12	47	45	47	42	44	43	46	50	47	50	43	49	52	60	45	51	71
13	52	46	38	30	43	39	46	39	52	53	53	55	42	50	57	68	60

Slave

3	40	40	49	44	49	48	53	50	56	52	55	60	56	64	99	67	57
4	43	43	53	47	53	49	56	51	60	56	56	63	56	66	99	70	64
5	40	40	48	43	48	47	50	48	54	51	50	57	51	66	55	61	58
6	38	38	45	41	44	44	46	43	49	50	56	54	50	54	51	58	57
7	47	47	52	47	51	50	54	50	56	54	56	61	55	63	57	65	63
8	44	44	52	47	45	49	46	44	51	54	48	54	48	54	51	56	58
9	39	39	40	40	41	41	46	44	51	47	48	59	48	59	58	65	58
10	49	49	50	49	49	49	52	49	54	54	55	59	56	64	56	63	64
11	40	40	40	41	41	41	46	49	54	51	50	56	45	64	54	64	64
12	40	40	40	41	41	41	46	41	53	46	54	62	55	64	63	65	64
13	49	49	49	49	49	49	51	49	54	54	57	57	55	58	59	58	56

Supply Spool

1	62	39	45	42	46	44	48	45	48	49	49	51	49	53	51	55	62
2	63	39	47	42	47	45	58	46	51	51	51	54	52	57	46	60	63

ENCLOSURE 10

SECRET

~~SECRET~~

J-5 1174 TEMPERATURE SUMMARY

Sensor	L	9	16	25	31	41	47	49	56	63	72	78	88	94	104	110
<u>Fairing & Barrel No. 1</u>																
1	-	7	4	7	7	4	4	-15	1	1	4	4	1	4	1	4
2	-	-19	-28	-15	-28	-15	-28	-28	-3	-13	0	-10	-3	-7	1	-4
3	-	0	-8	-8	-8	-8	-8	-14	22	35	19	35	13	48	-3	-8
4	207	30	27	30	27	30	20	20	39	62	36	52	27	52	16	43
5	222	43	34	40	27	34	21	18	40	43	37	40	27	27	27	41
6	235	37	43	37	42	31	37	11	40	43	37	40	27	30	27	18
<u>Barrel No. 2</u>																
1	147	59	73	56	64	53	62	59	50	50	43	46	37	37	46	24
2	235	-16	85	52	85	46	36	49	46	64	39	58	29	55	29	14
3	184	25	40	28	50	25	50	15	22	0	22	34	15	43	18	41
4	191	5	4	5	4	5	-1	8	2	-11	2	-8	-1	-4	2	6
5	179	16	13	13	16	16	16	10	3	0	3	3	0	3	3	5
<u>Canis Adaptor</u>																
1	159	64	62	63	59	62	53	46	59	43	56	43	46	33	46	24
<u>Clock</u>																
1	94	68	64	70	64	68	64	67	64	56	64	58	60	54	63	31
2	90	64	58	63	58	64	60	58	58	52	56	50	56	48	56	14
<u>Thrustcone</u>																
1	-	29	19	23	15	20	15	13	36	33	36	35	36	32	36	32
2	68	43	29	30	26	31	23	25	42	40	42	40	40	37	39	36
<u>Stellar Index</u>																
2	82	46	36	39	33	36	33	29	46	36	42	39	39	36	42	30
<u>Recovery Battery No. 2</u>																
1	73	69	62	58	55	54	55	98	98	98	97	99	99	98	96	98
<u>Master Cassette</u>																
2	88	50	41	32	38	40	42									

ENCLOSURE 11

~~SECRET~~

SECRET
SECRET

KOE 10 X 10 TO THE INCH
KUFFEL & ESSER CO. MADE IN U.S.A.

1074-15 MURDER SYSTEM
TERRA SENSORS SENSITIVE MATERIALS



SECRET (TOP SECRET)

SECRET (TOP SECRET)

SECRET



SECRET
SECRET

K-E 10 X 10 TO THE CM. 359-14
KEUFFEL & LUBER CO. MADE IN U.S.A.

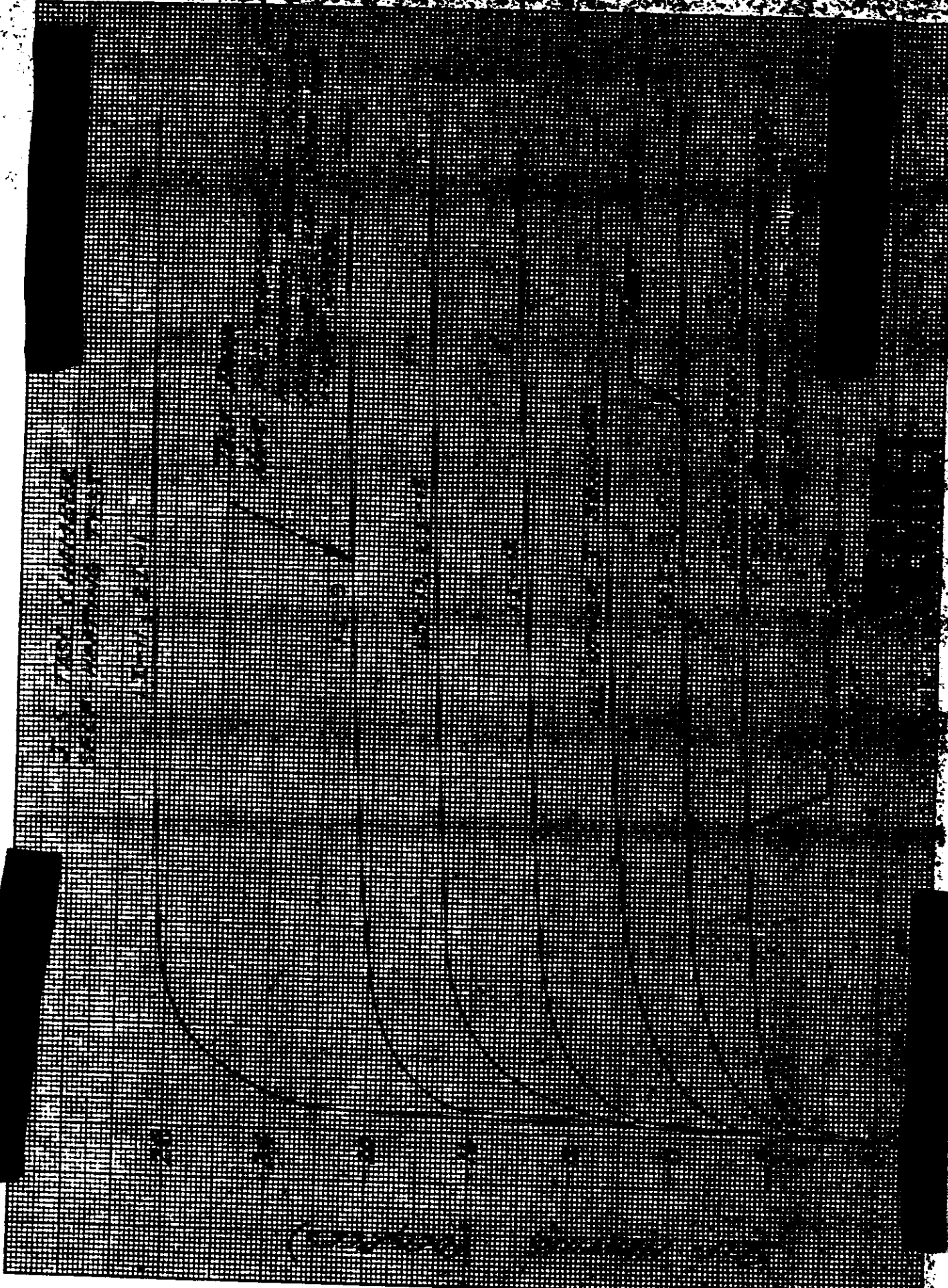

"J" PROFILE TO SHOW APPLX.
TEMP SENSOR LOCATIONS

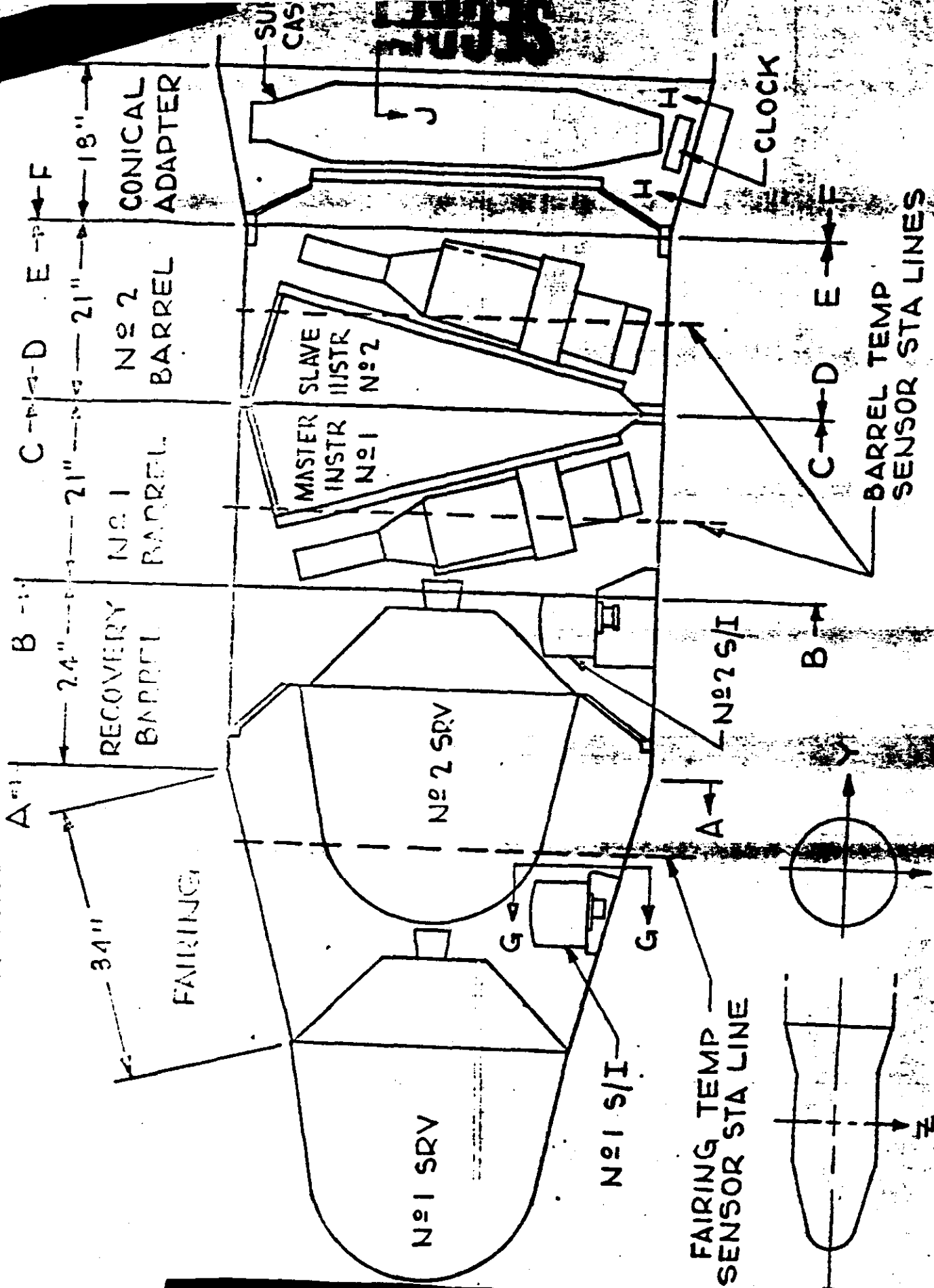

ENCLOSURE 14

FAIRING TEMP SENSORS

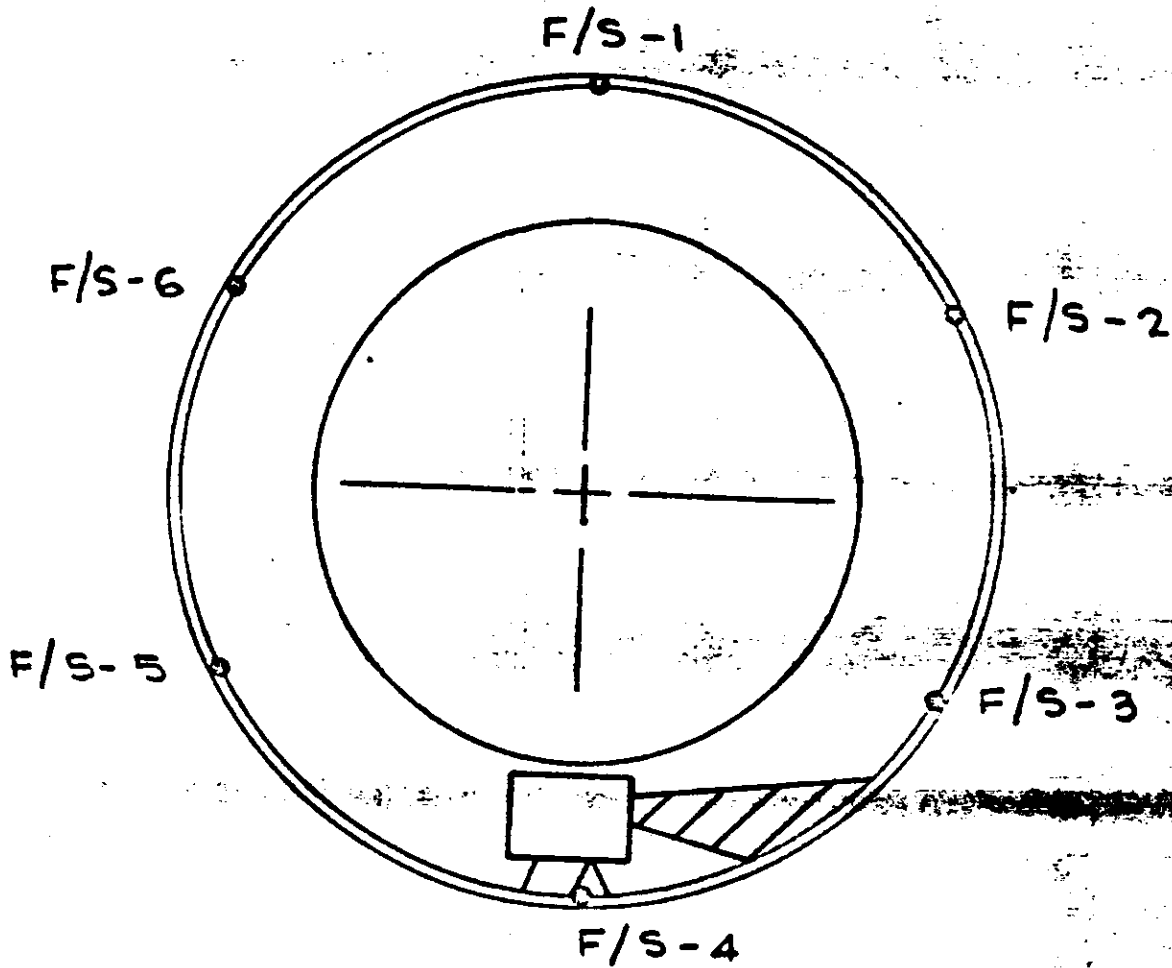

VIEW A-A
LOOKING FORWARD

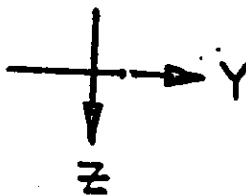

ENCLOSURE 15

SECRET

NO 1 & NO 2 INSTR TEMP SENSORS (FRONT FACE)
 NO 1 & NO 2 BARREL TEMP SENSORS (SKIN)

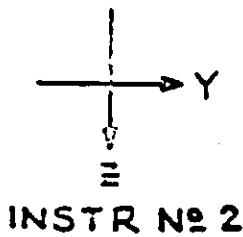
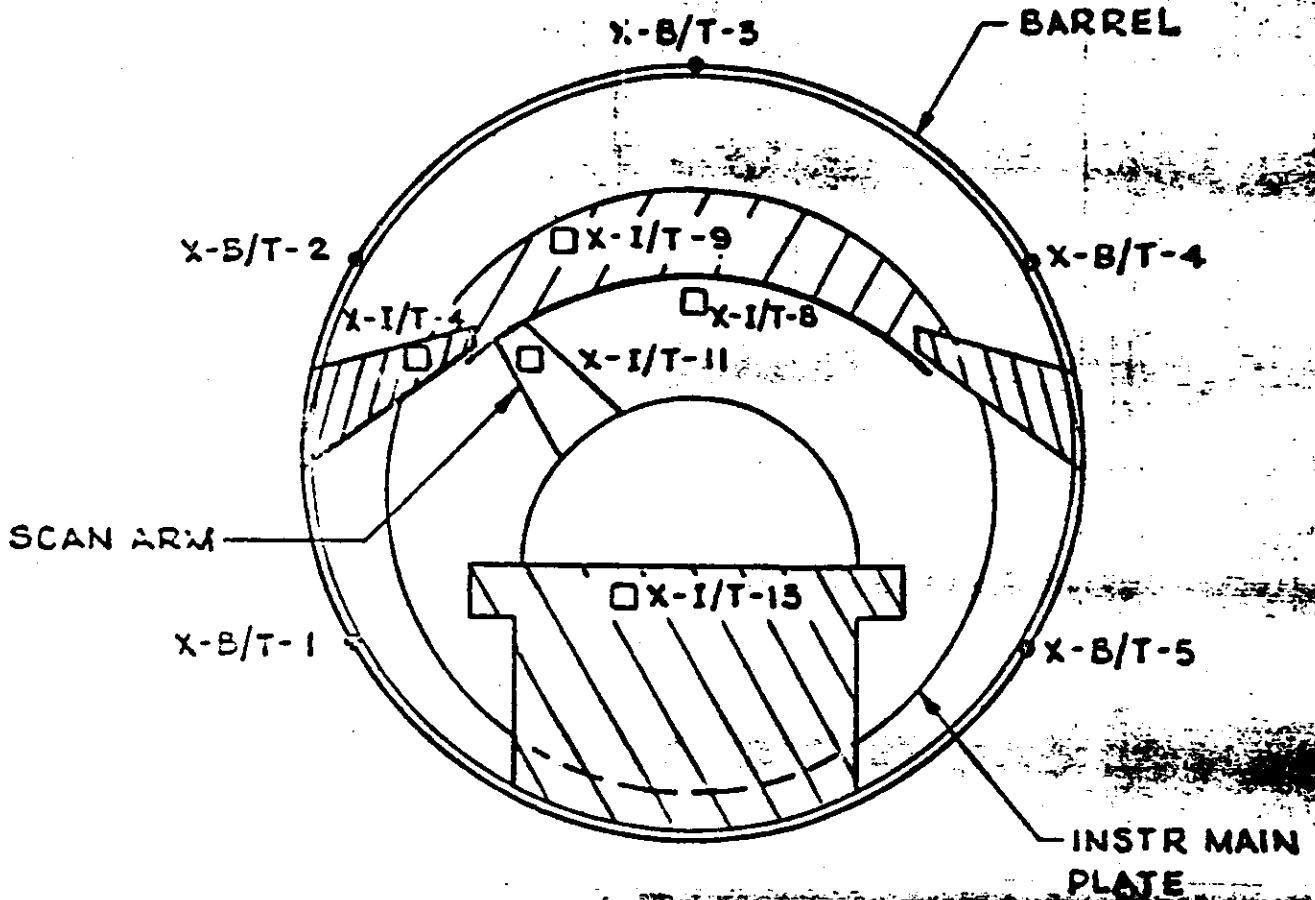

VIEW B-B & F-F
 INSTR NO 1 LOOKING AFT.
 INSTR NO 2 LOOKING FWD

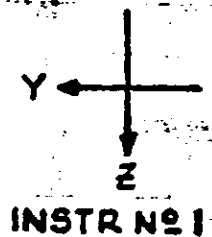

KEY:
 SEE KEY, PAGE 4 OF 9

SECRET

ENCLOSURE 16
 SHT 3 OF 7

SECRET

NO 1 & NO 2 INSTR TEMP SENSORS (BACKFACE)
 NO 1 & NO 2 BARREL TEMP SENSORS (SKIN)

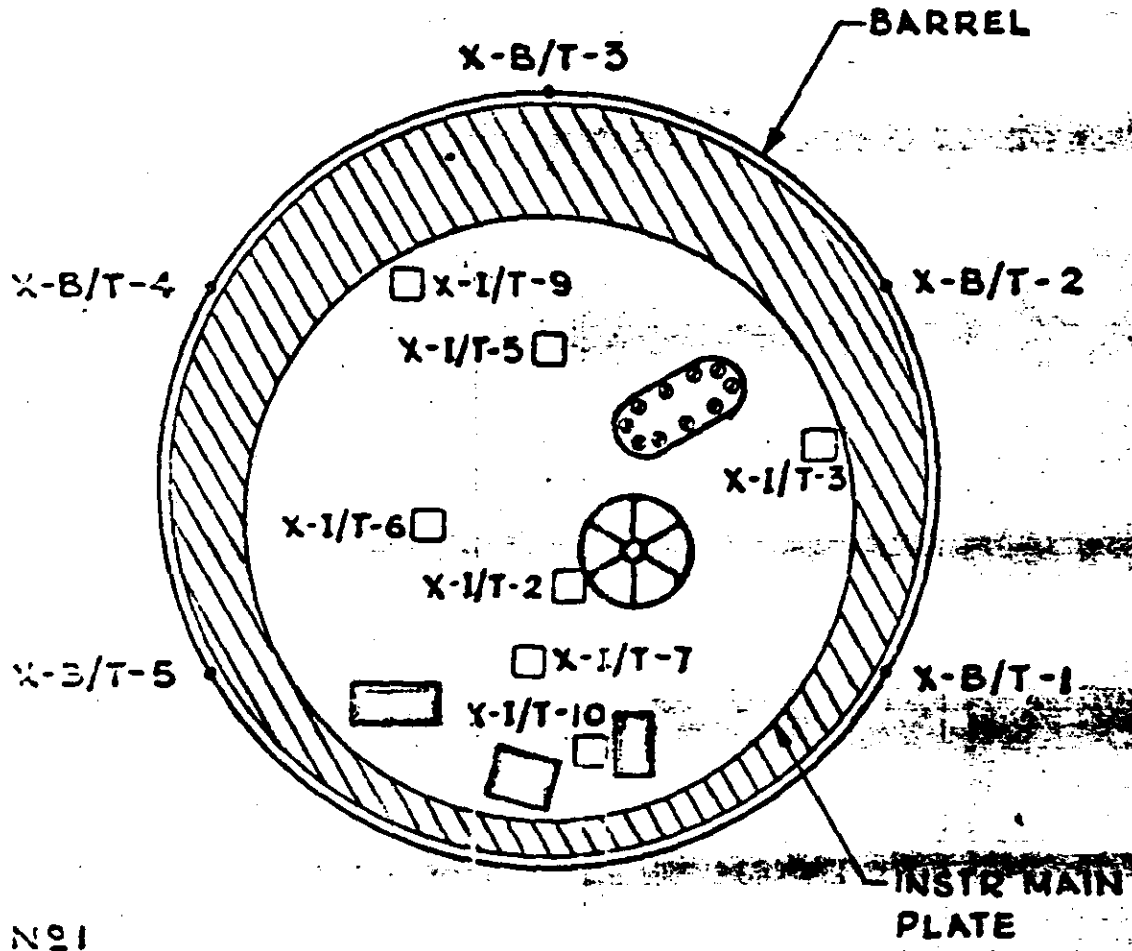

INSTR NO 1

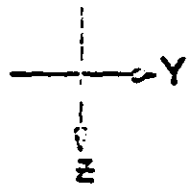

VIEW C-C & D-D
 INSTR NO 2 LOOKING AFT
 INSTR NO 1 LOOKING FWD

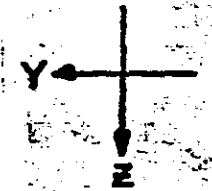

INSTR NO 2

KEY:

- X DENOTES NO 1 OR NO 2 INSTR OR BARREL
- e.g. X-I/T-6 IS NO 1 OR NO 2 INSTR - INSTR TEMP SENSOR NO 6
- X-B/T-4 IS NO 1 OR NO 2 BARREL TEMP SENSOR NO 4

SECRET



ENCLOSURE 13

SECRET

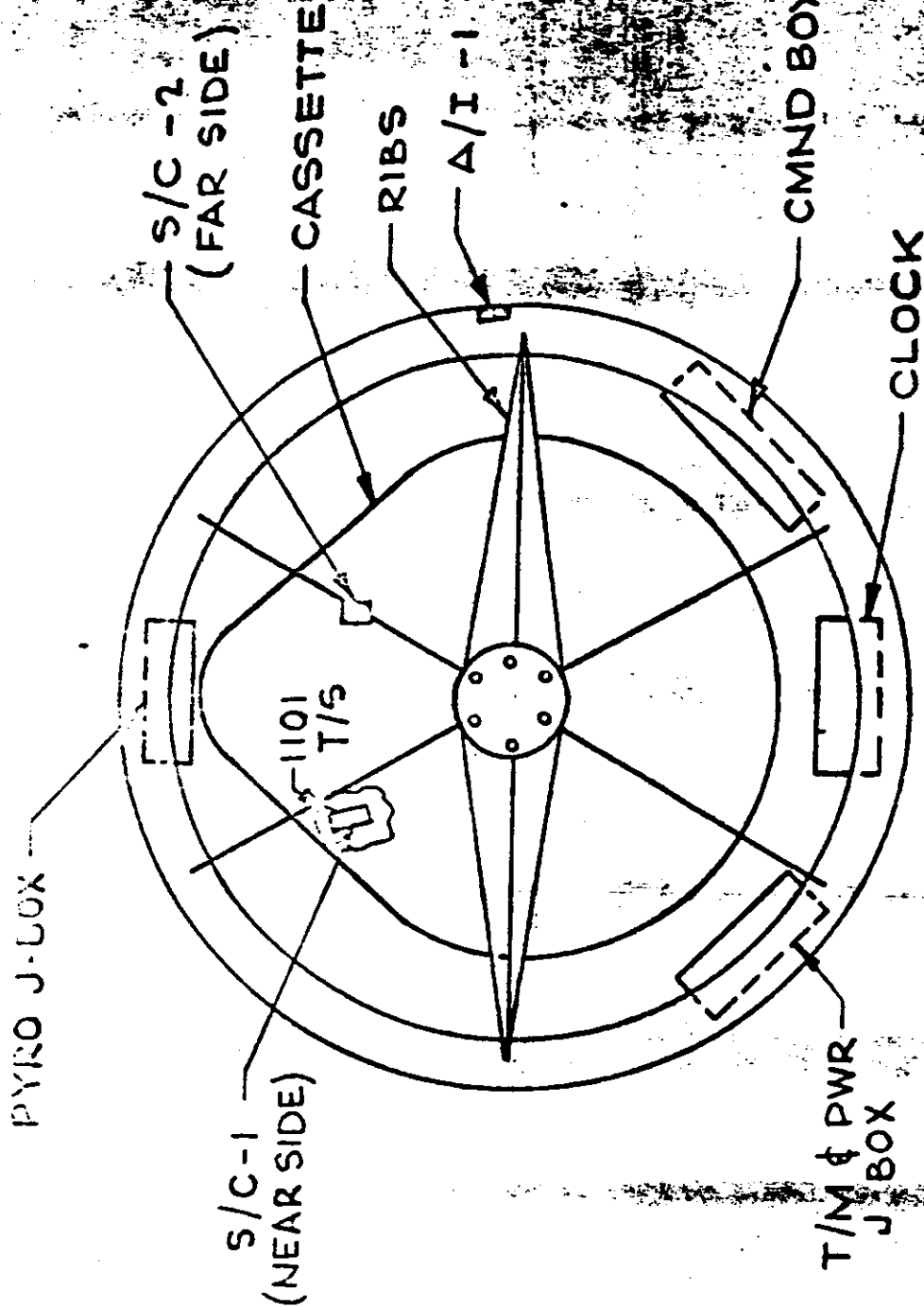

VIEW E-E
SUPPLY CASSETTE
LOOKING AFT

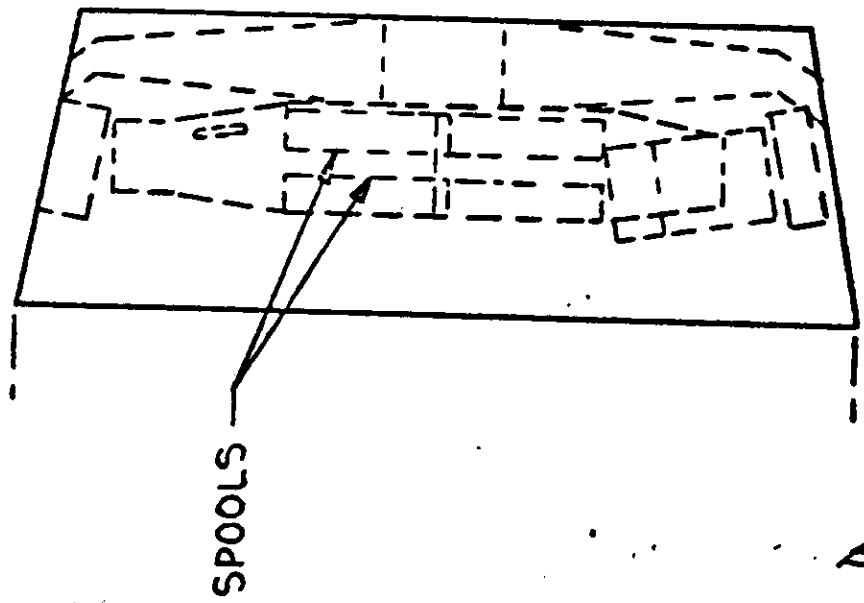

SIDE VIEW
SHOWING SPOOLS



SECRET

~~SECRET~~

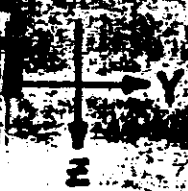

X-5/1-1

INDEX LENS



STELLAR LENS

VIEW G-G
S/I TEMP SENSOR

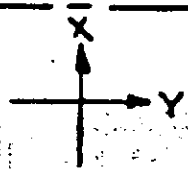

CL-2

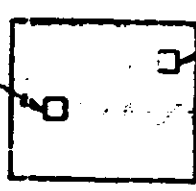

CL-1

VIEW H-H
CLOCK TEMP SENSOR

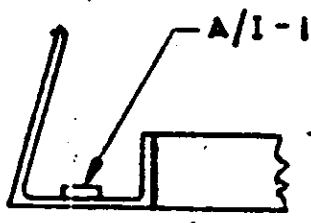
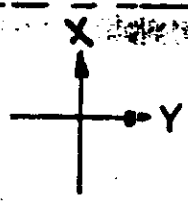

A/I-1

VIEW J-J
INTERFACE TEMP SENSOR
(SENSOR ON -Y AXIS)

~~SECRET~~

ENCLOSURE 1

~~SECRET~~

NS-2 CONE TEMP SENSOR



HEAT SHIELD

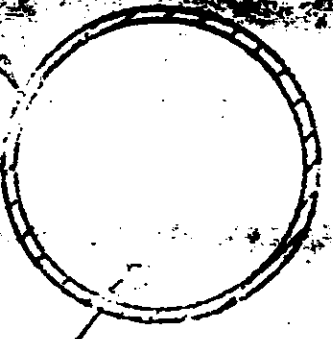
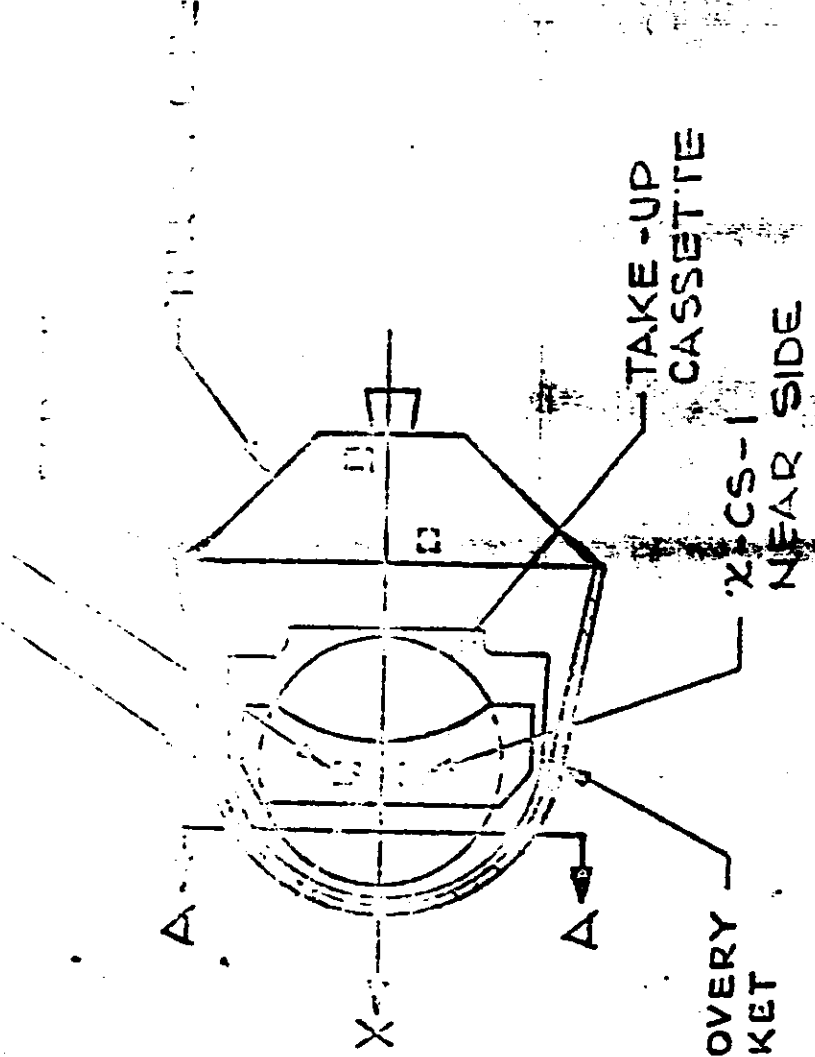
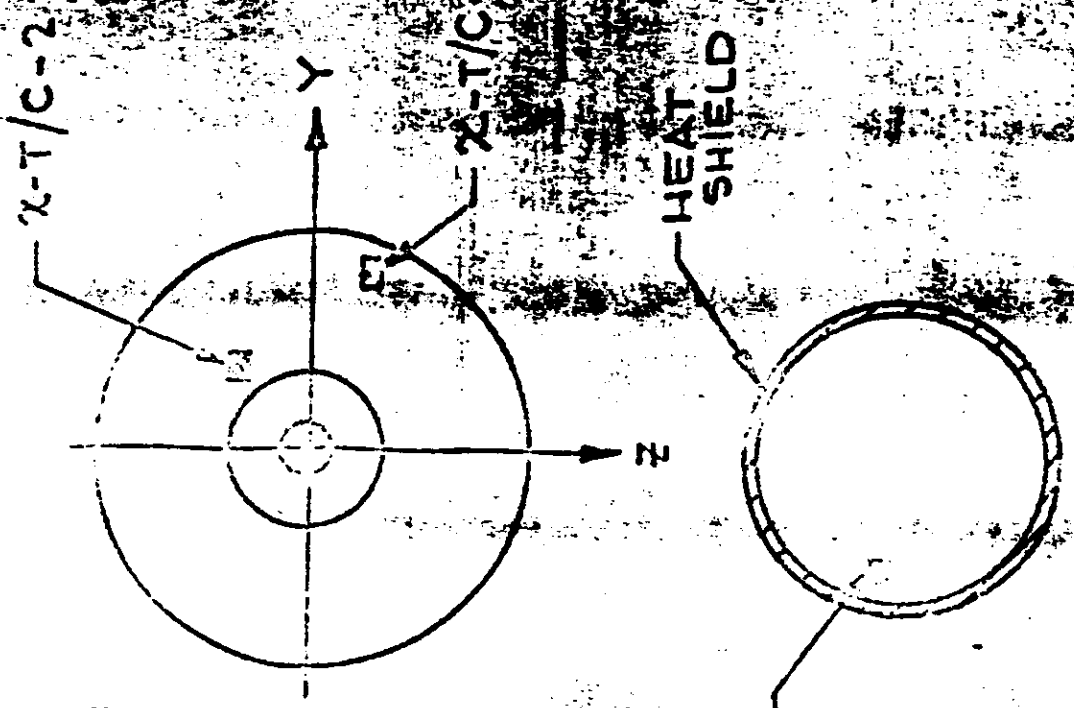

RECOVERY BUCKET

TAKE-UP CASSETTE

X-CS-1 NEAR SIDE

HEAT SHIELD

X-H/S-1

KEY:

X DENOTES
NS-1 OR NS-2 SRV
e.g.

X-T/C IS
NS-2 SRV-THRUST
CONE TEMP SENSOR-2



ENCLOSURE 20

SH 7 CF 7

SECTION A-A

~~SECRET~~

SKIN T AND INTERNAL TEMPERATURES VS. DRETT NO. N-5 VEHICLE 1174

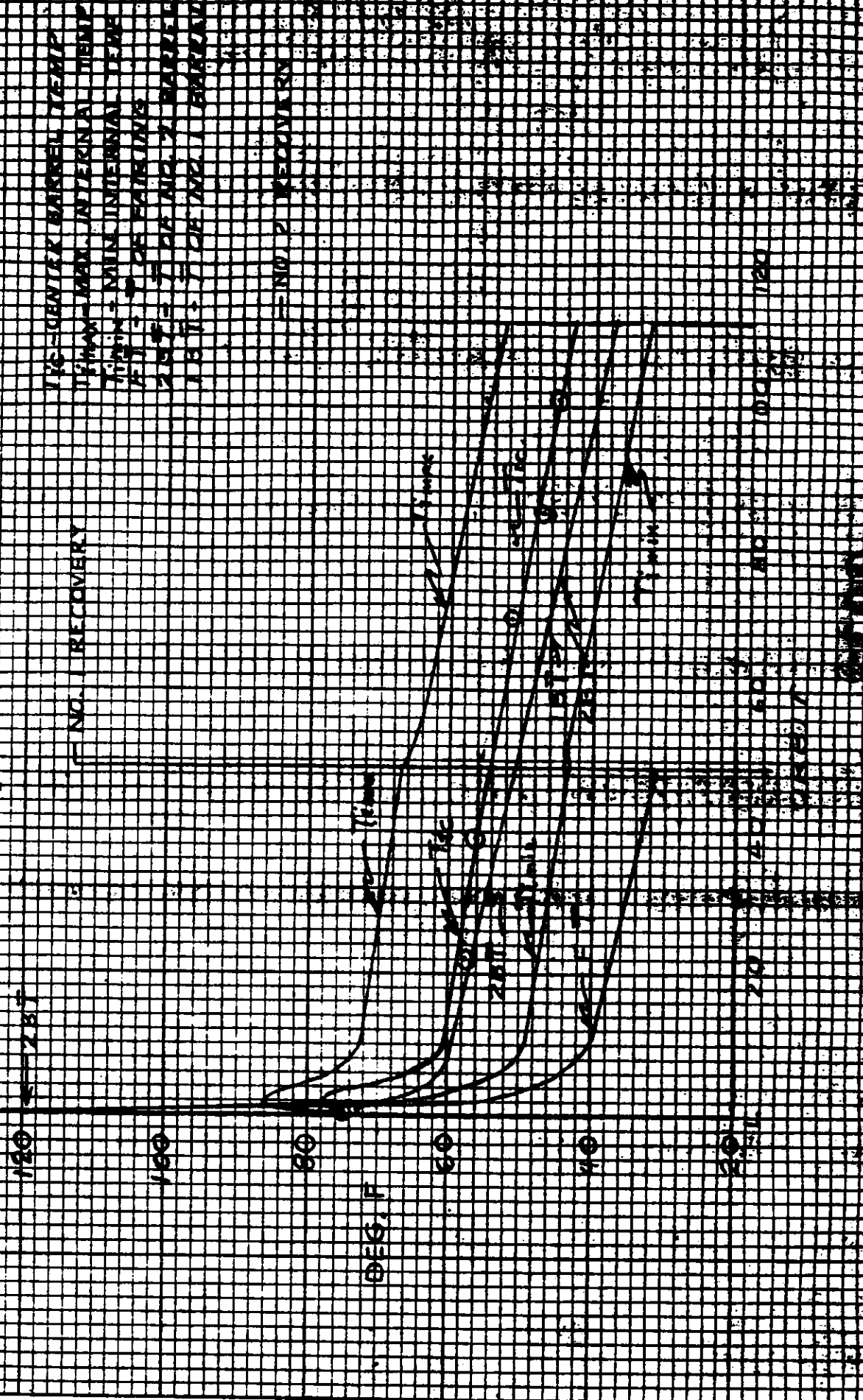

**KEUFFEL
& ESSER**

FLYING (10-05)
13 1/2 REV. NO.

REV. 1 DRAIN EXHAUSTION
BY 3 1/2" DIA. PIPE
EFF. 11.02/100
1.3 10.00
1.5 10.00

INJECTION TUBING
2 1/2" DIA. x 10' L.
15' DIA. TUBING

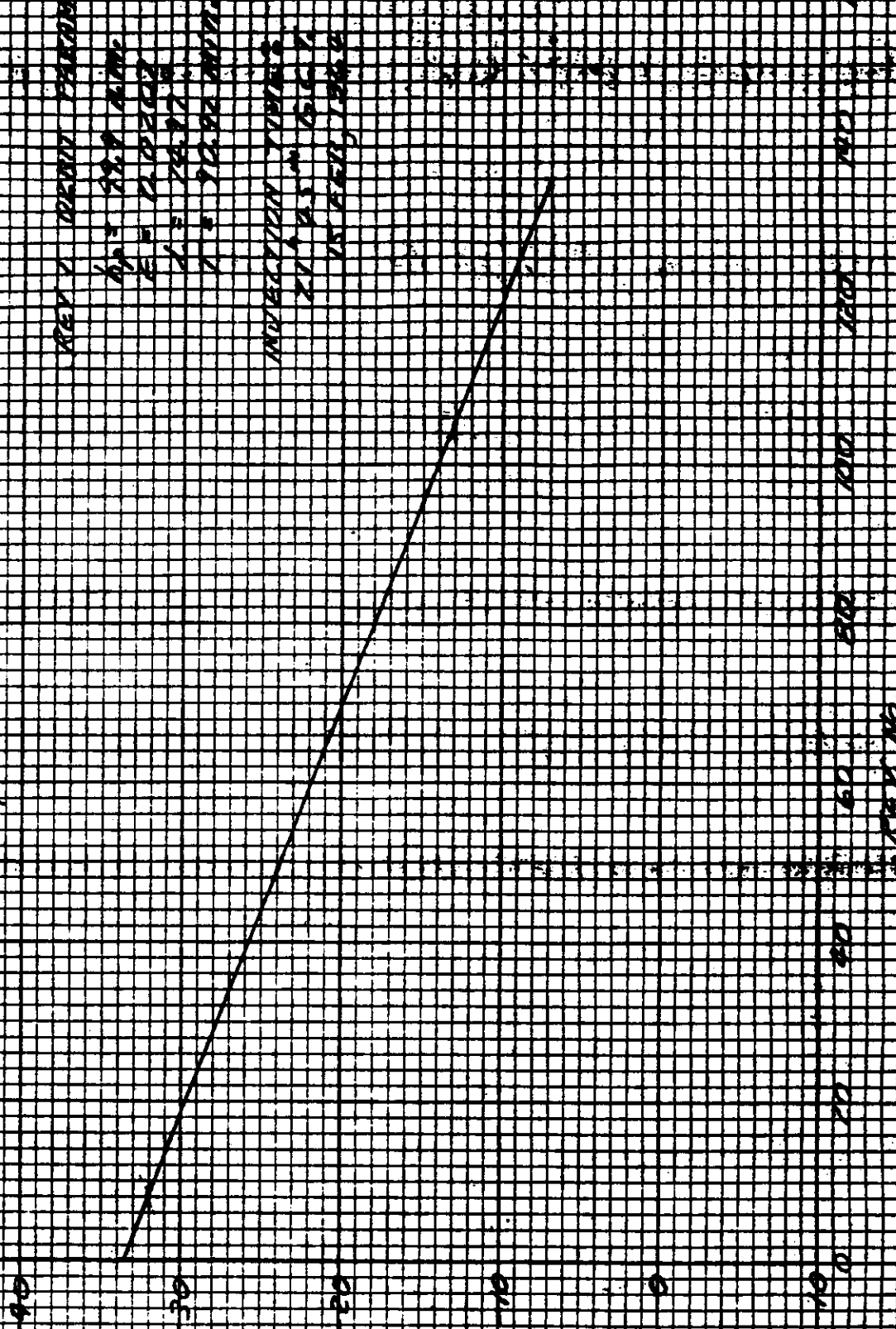

REV. 1

**KEUFFEL
& ESSER**

SKIN T AND BARREL CENTER TEMP
 VS. SUN ANGLE
 D-5 VEHICLE 1174

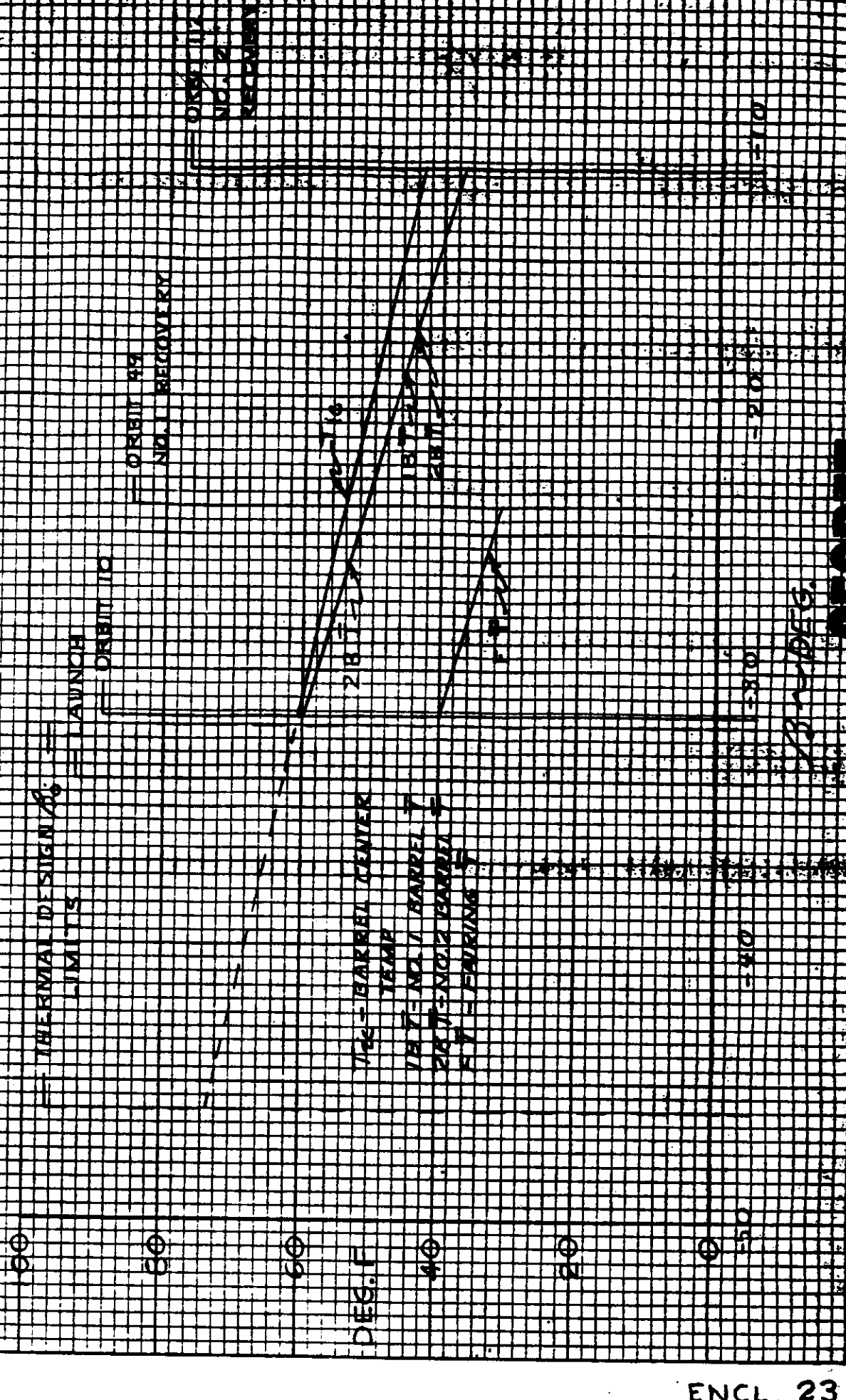

THESE LIMITS ARE LAUNCH

ORBIT 10

NO. 1 RECOVERY

ORBIT 10
 NO. 2
 RECOVERY

SKIN T
 BARREL CENTER
 TEMP

40

50

60

70

80

90

0

10

20

30

40

50

60

70

80

90

~~SECRET~~

APPENDICES

TAPE RECORDED THERMAL DATA

~~SECRET~~
~~SECRET~~

[REDACTED]

VEHICLE 1174 TEMPERATURE DATA-ORBIT 0

ASCENDING NODE=ZERO PL TIME= 75954.6 SYSTEM TIME

PL TIME IN HRS.	FS-2	HALF	FS-1	11-3	FS-4	11-4	FS-3	11-5
0.80	205.4	2.5	229.9	69.0	177.8	74.0	201.2	67.2
0.85	205.4	2.5	221.4	71.3	166.9	76.8	177.6	68.7
0.90	180.1	2.5	212.1	73.7	155.4	80.1	156.0	70.9
0.95	159.8	2.5	205.1	76.1	146.0	81.8	141.4	72.6
1.00	143.6	2.5	197.4	76.6	140.0	83.2	129.5	74.0
1.05	128.9	2.5	187.9	77.7	135.0	85.2	118.4	75.3
1.10	117.6	2.5	178.6	78.7	128.7	86.1	110.0	77.3
1.15	104.7	2.5	164.3	79.5	126.4	87.2	100.1	77.4
1.20	96.9	2.5	149.9	79.9	125.9	87.0	91.5	79.0
1.25	85.2	2.5	134.0	79.7	125.5	86.9	84.8	79.2
1.30	79.0	2.5	119.4	79.8	124.0	87.6	74.6	80.2
1.35	72.4	2.5	108.3	79.8	113.7	86.4	69.9	81.6
1.40	62.9	2.5	97.2	79.6	107.3	86.2	64.0	80.8
1.45	58.5	2.5	88.9	79.5	100.3	86.0	60.3	81.7
1.50	53.1	2.5	79.5	79.2	95.2	84.9	57.1	81.4
1.55	47.2	2.5	71.6	78.7	91.6	84.6	52.9	81.6
1.60	45.4	2.5	63.8	77.6	89.3	83.3	49.9	81.4
1.65	38.9	2.5	57.1	77.4	83.5	82.8	46.8	81.0
1.70	34.6	2.5	51.7	76.9	80.4	81.3	43.4	80.4
1.75	29.7	2.5	46.7	76.1	74.3	80.6	39.7	79.7
1.80	26.2	2.5	41.5	74.8	72.0	79.2	35.7	79.2
1.85	23.6	2.5	38.2	74.5	68.3	77.9	34.8	79.3
1.90	20.9	2.4	31.0	73.6	67.2	77.2	28.4	78.4
1.95	17.8	2.5	28.9	72.5	62.7	75.6	27.7	77.7
2.31	205.4	2.5	229.9	69.0	177.8	74.0	201.2	67.2

4TH PWR AVG 120.7 2.5 155.2 75.4 128.7 81.2 117.1 75.7

[REDACTED]

VEHICLE 1174 TEMPERATURE DATA-ORBIT 0

ASCENDING NOCE=ZERO PL TIME= 75954.6 SYSTEM TIME

PL TIME IN HRS.	FS-6	11-6	FS-5	11-7	2B-2	11-8	2B-1	11-9
0.80	187.2	63.3	178.3	61.9	139.5	70.9	129.5	67.3
0.85	188.5	65.0	164.6	63.3	153.2	71.6	124.1	69.8
0.90	188.9	65.6	154.0	64.0	164.5	74.3	123.1	72.7
0.95	188.5	66.7	148.9	65.5	169.4	76.2	119.5	75.1
1.00	190.1	67.6	147.5	66.0	172.0	78.1	120.3	77.3
1.05	189.4	68.6	148.3	66.5	173.5	80.2	124.9	78.9
1.10	186.7	69.9	149.8	67.6	171.1	81.1	126.6	81.6
1.15	182.7	71.0	152.8	69.1	166.1	82.4	129.8	82.9
1.20	177.4	72.3	157.2	69.6	160.5	83.3	133.9	83.7
1.25	171.7	72.9	159.5	70.3	153.2	84.2	136.9	84.8
1.30	156.9	73.1	154.9	70.9	142.1	85.1	134.1	85.7
1.35	139.3	74.7	139.2	70.7	127.7	85.6	120.1	85.5
1.40	123.5	75.0	124.1	72.0	115.3	85.4	111.6	85.1
1.45	110.6	75.9	114.7	72.6	107.3	84.9	104.8	85.6
1.50	101.6	76.1	105.6	72.7	98.8	85.3	98.8	85.0
1.55	93.3	76.3	97.7	73.6	90.5	84.3	94.0	84.7
1.60	83.7	76.3	91.6	72.9	83.7	84.6	89.4	84.5
1.65	76.5	77.0	86.4	74.1	76.5	84.1	84.9	83.3
1.70	70.8	77.1	80.2	73.5	71.6	82.7	80.4	82.6
1.75	65.1	76.9	74.4	73.2	66.0	82.2	74.8	81.8
1.80	59.4	76.4	69.2	72.8	62.4	82.0	72.1	80.9
1.85	55.8	76.9	65.5	73.6	57.9	81.2	71.8	79.8
1.90	55.0	77.3	70.0	73.9	63.9	80.1	84.6	79.0
1.95	55.1	76.4	68.6	73.8	71.6	79.5	91.9	78.4
2.31	187.2	63.3	178.3	61.9	139.5	70.9	129.5	67.3

4TH PWR AVG 149.8 70.9 136.4 68.5 129.7 79.1 113.1 78.2



SECRET

 VEHICLE 1174 TEMPERATURE DATA-ORBIT 0

ASCENDING NODE=ZERO PL TIME= 75954.6 SYSTEM TIME

PL TIME IN HRS.	11-11	11-10	SC-1	28-3	11-13	28-4	11-12	28-5
0.80	84.3	66.7	68.7	184.6	67.3	184.6	81.6	155.0
0.85	85.1	67.7	70.2	185.6	68.2	166.1	83.8	145.0
0.90	86.9	69.2	72.4	186.6	69.2	152.3	86.2	137.0
0.95	86.5	70.2	72.8	183.8	70.4	140.1	88.7	128.9
1.00	87.0	71.2	74.5	177.7	71.6	130.3	88.9	123.5
1.05	86.6	72.5	74.7	170.6	71.9	120.6	90.0	119.2
1.10	86.7	73.5	75.6	159.7	73.4	114.3	90.7	113.1
1.15	86.3	73.8	75.7	146.2	73.6	105.0	90.8	106.3
1.20	85.3	74.8	76.5	131.6	74.6	97.2	91.8	99.1
1.25	84.6	74.8	75.8	120.0	75.6	90.9	90.3	93.2
1.30	84.1	75.2	76.2	109.3	76.0	85.6	90.5	88.0
1.35	82.8	76.9	76.8	99.9	76.5	78.9	90.0	82.4
1.40	82.0	76.3	76.4	92.9	76.7	72.8	89.2	79.4
1.45	81.4	76.0	76.1	87.6	77.1	69.7	88.4	75.5
1.50	80.0	75.7	75.8	80.3	77.1	65.4	87.6	71.5
1.55	79.3	75.2	75.7	74.3	77.9	61.2	85.9	69.9
1.60	78.2	75.3	75.2	68.4	77.2	56.7	84.8	66.2
1.65	76.7	75.1	74.3	63.8	77.2	54.6	83.7	64.1
1.70	75.7	74.5	74.3	58.7	77.1	50.0	82.5	61.2
1.75	74.9	74.4	74.0	53.5	77.1	45.4	81.5	59.7
1.80	74.6	73.7	73.6	52.3	77.2	43.0	80.0	56.5
1.85	73.6	73.6	73.1	48.4	77.4	42.3	79.4	54.5
1.90	72.4	73.7	72.0	45.2	77.5	38.1	77.8	50.0
1.95	71.9	73.6	71.0	43.1	77.3	35.5	76.9	48.6
2.31	84.3	66.7	68.7	184.6	67.3	184.6	81.6	155.0

4TH PWR AVG 82.1 72.1 73.2 134.7 73.2 114.7 85.4 ~~107.1~~

SECRET

 VEHICLE 1174 TEMPERATURE DATA-ORBIT 0

ASCENDING NOCE=ZERO PL TIME= 75954.6 SYSTEM TIME

PL TIME IN HRS.	2I-4	AI-1	2I-3	CL-1	ITC-1	CL-2	+28BU	2I-5
0.80	73.2	142.4	64.4	103.2	114.6	100.2	28.2	65.9
0.85	75.1	141.0	66.8	107.8	114.4	103.2	28.2	67.5
0.90	77.9	138.0	69.4	108.9	112.9	105.1	28.2	69.4
0.95	80.1	137.6	70.9	108.7	110.6	105.1	28.2	71.2
1.00	82.2	138.0	73.1	110.0	108.8	106.1	28.2	72.4
1.05	84.4	139.6	74.8	110.9	106.2	106.1	28.2	73.8
1.10	85.9	141.4	76.6	110.2	104.4	107.2	28.2	75.1
1.15	87.5	141.9	78.2	110.7	101.4	106.0	28.2	76.7
1.20	89.0	143.7	79.4	110.5	99.3	104.9	28.2	77.3
1.25	90.4	143.3	80.9	109.8	97.0	104.8	28.2	78.9
1.30	91.0	138.5	81.5	109.8	94.2	105.1	28.2	79.1
1.35	91.5	128.5	82.4	110.2	92.3	103.7	28.2	80.5
1.40	91.2	120.8	82.9	109.9	90.3	104.1	28.2	80.1
1.45	91.4	113.5	83.5	107.8	88.5	102.9	28.2	81.0
1.50	91.6	107.2	84.1	108.5	86.0	102.9	28.2	81.6
1.55	90.8	102.7	83.6	107.2	84.2	101.5	28.2	81.6
1.60	89.8	99.5	83.4	106.8	81.9	100.7	28.2	81.2
1.65	89.4	95.1	82.9	105.8	80.4	100.0	28.2	81.5
1.70	88.4	91.6	82.1	104.5	77.9	99.9	28.2	81.0
1.75	87.9	86.0	82.0	104.1	76.0	98.0	28.2	80.8
1.80	86.4	83.2	80.5	101.4	73.8	96.7	28.2	79.6
1.85	85.9	80.9	80.8	101.2	72.6	95.8	28.2	79.8
1.90	85.7	82.5	80.4	100.7	70.2	94.9	28.2	78.9
1.95	83.6	81.7	79.1	100.1	68.1	94.3	28.2	78.3
2.31	73.2	142.4	64.4	103.2	114.6	100.2	28.2	65.9

4TH PWR AVG 83.8 124.7 75.8 106.9 98.0 102.2 28.2 75.0



SECRET

[REDACTED]

VEHICLE 1174 TEMPERATURE DATA-ORBIT 0

ASCENDING NODE=ZERO PL TIME= 75954.6 SYSTEM TIME

PL TIME IN HRS.	21-7	21-6	ITC-2	SC-2	-28BU	151-2	21-8	1C-2
0.80	64.1	63.2	78.2	70.3	28.0	93.2	71.7	92.3
0.85	65.1	64.2	81.0	71.2	28.0	96.4	73.9	92.1
0.90	65.4	65.7	83.2	73.6	28.0	97.7	75.5	91.2
0.95	66.9	66.5	84.0	75.0	28.0	99.9	77.1	90.5
1.00	68.1	67.6	84.8	76.3	28.0	101.6	79.4	91.0
1.05	69.1	69.7	85.7	78.1	28.0	102.8	80.4	90.8
1.10	69.7	69.7	86.2	79.4	28.0	103.9	82.6	90.7
1.15	71.3	70.7	87.6	80.0	28.0	102.1	83.7	90.3
1.20	71.8	71.9	86.0	81.1	28.0	102.3	85.4	90.9
1.25	72.3	72.6	86.6	81.5	28.0	103.6	86.5	90.3
1.30	73.3	73.3	87.7	81.8	28.0	103.1	86.3	90.3
1.35	73.3	73.6	86.8	83.2	28.0	101.2	87.4	90.3
1.40	74.6	74.6	86.7	82.4	28.0	100.5	87.0	90.6
1.45	74.5	74.5	86.5	82.3	28.0	100.7	87.7	90.5
1.50	75.5	75.0	85.6	82.3	28.0	99.5	87.8	90.4
1.55	75.5	75.1	85.0	82.0	28.0	99.7	88.0	90.2
1.60	75.2	75.2	83.7	81.6	28.0	100.1	87.1	89.9
1.65	75.2	75.5	82.9	80.7	28.0	96.3	86.7	90.1
1.70	75.8	75.3	81.9	80.0	28.0	96.1	86.2	90.0
1.75	75.4	75.3	80.9	79.0	28.0	95.0	85.7	89.8
1.80	75.1	74.6	79.8	78.3	28.0	92.7	85.1	89.2
1.85	75.3	74.8	78.0	78.1	28.0	92.9	84.2	90.0
1.90	74.8	74.3	76.5	77.6	28.0	90.6	83.6	90.1
1.95	74.4	75.4	75.9	76.9	28.0	89.6	82.8	89.0
2.31	64.1	63.2	78.2	70.3	28.0	93.2	71.7	92.3
4TH PWR AVG	70.5	70.2	82.7	77.2	28.0	97.8	81.2	90.9

[REDACTED]

VEHICLE 1174 TEMPERATURE DATA-ORBIT 0

ASCENDING NODE=ZERO PL TIME= 75954.6 SYSTEM TIME

PL TIME IN HRS.	21-11	21-9	+28C1	21-10	+28C2	-28C1	21-12	28AT
0.80	72.5	74.3	28.5	64.6	28.5	4.1	73.2	80.1
0.85	74.2	76.4	28.5	66.7	28.6	4.1	75.7	81.3
0.90	76.4	79.0	28.3	67.8	28.5	4.1	78.6	81.0
0.95	78.4	80.6	28.4	68.8	28.5	4.1	81.4	81.4
1.00	78.7	82.3	28.3	70.2	28.6	4.1	83.0	82.0
1.05	80.6	84.0	28.4	71.4	28.5	4.1	85.4	82.1
1.10	81.3	84.8	28.3	72.7	28.5	4.1	87.3	82.2
1.15	82.6	85.6	28.4	73.4	28.5	4.1	88.8	82.8
1.20	82.9	86.0	28.5	74.4	28.6	4.1	89.4	83.3
1.25	83.8	86.7	28.5	74.6	28.6	4.1	90.3	83.4
1.30	84.6	86.8	28.3	74.8	28.5	4.1	91.2	83.2
1.35	84.1	88.1	28.4	75.3	28.6	4.1	90.1	83.9
1.40	83.1	87.6	28.4	75.3	28.5	4.1	90.3	83.9
1.45	83.1	87.1	28.5	75.6	28.6	4.1	89.3	84.3
1.50	82.4	87.6	28.4	74.8	28.6	4.1	89.7	84.6
1.55	81.3	87.4	28.4	75.0	28.6	4.1	88.6	85.1
1.60	80.0	86.4	28.4	74.6	28.6	4.1	87.7	84.8
1.65	79.4	86.2	28.4	74.7	28.5	4.1	86.6	85.1
1.70	78.3	85.7	28.5	74.4	28.6	4.1	85.4	85.3
1.75	76.7	85.0	28.5	73.7	28.5	4.1	84.1	85.4
1.80	76.0	83.9	28.3	72.8	28.5	4.1	83.2	85.5
1.85	74.8	83.6	28.4	72.9	28.5	4.1	82.0	85.7
1.90	74.2	82.5	28.5	73.3	28.6	4.1	80.6	85.8
1.95	73.6	82.2	28.2	72.6	28.4	4.1	80.1	85.9
2.31	72.5	74.3	28.5	64.6	28.5	4.1	73.2	80.1

4TH PWR AVG 78.1 82.3 28.4 71.2 28.6 4.1 82.9 83.0

~~SECRET~~

VEHICLE 1174 TEMPERATURE DATA-ORBIT 0

ASCENDING NODE=ZERO PL TIME= 75954.6 SYSTEM TIME

PL TIME IN HRS.	21-13	-28C2
0.80	62.7	4.1
0.85	63.4	4.1
0.90	64.5	4.1
0.95	65.5	4.1
1.00	66.2	4.1
1.05	66.4	4.1
1.10	68.0	4.1
1.15	68.6	4.0
1.20	69.6	4.0
1.25	70.2	4.1
1.30	71.0	4.1
1.35	71.9	4.1
1.40	72.2	4.1
1.45	72.8	4.1
1.50	73.4	4.1
1.55	74.0	4.0
1.60	74.2	4.1
1.65	75.0	4.0
1.70	74.7	4.0
1.75	75.4	4.1
1.80	75.2	4.1
1.85	75.3	4.1
1.90	75.3	4.1
1.95	75.1	4.1
2.31	62.7	4.1

4TH PWR AVG - 69.1 4.1

~~SECRET~~
~~SECRET~~

[REDACTED]

VEHICLE 1174 TEMPERATURE DATA-ORBIT 1

ASCENDING NODE=ZERO PL TIME= 81388.2 SYSTEM TIME

PL TIME IN HRS.	FS-2	HALF	FS-1	11-3	FS-4	11-4	FS-3	11-5
0.60	12.2	2.5	37.0	74.2	65.5	75.9	31.5	79.0
0.65	10.0	2.5	44.9	72.8	65.8	74.2	32.6	78.3
0.70	14.1	2.5	60.5	72.0	70.5	74.6	36.7	78.4
0.75	13.7	2.5	71.2	71.1	72.6	73.7	37.1	77.5
0.80	15.8	2.5	85.5	70.9	72.3	73.5	36.6	77.4
0.85	18.5	2.4	95.9	70.2	72.9	72.4	35.3	77.0
0.90	22.2	2.5	105.0	70.5	71.8	72.0	36.7	77.0
0.95	22.6	2.5	112.2	69.9	74.0	71.9	37.7	76.7
1.00	27.6	2.5	116.2	69.7	76.7	71.8	40.0	76.9
1.05	29.5	2.5	117.3	68.7	76.9	72.6	39.3	77.6
1.10	27.5	2.5	113.9	68.0	77.0	71.7	36.8	77.6
1.15	26.2	2.5	105.2	68.9	80.1	71.8	35.0	78.0
1.20	24.6	2.5	96.9	68.7	83.2	72.0	32.5	77.6
1.25	24.2	2.5	87.3	68.7	89.0	72.4	30.4	78.3
1.30	22.7	2.5	78.1	68.1	85.5	71.8	28.3	77.4
1.35	20.9	2.5	69.9	67.5	79.0	71.7	27.4	77.9
1.40	15.7	2.4	60.0	68.2	73.0	70.4	22.7	77.1
1.45	17.6	2.5	55.0	67.4	70.2	71.6	26.3	78.1
1.50	15.5	2.5	51.3	67.4	67.4	70.6	23.6	77.7
1.55	12.0	2.4	41.8	66.5	63.3	69.1	19.7	76.9
1.60	10.4	2.5	38.8	66.5	62.1	69.0	19.2	76.6
1.65	6.1	2.5	34.0	66.2	58.0	68.4	17.6	75.9
1.70	6.4	2.5	29.1	65.9	60.9	67.7	18.4	75.9
1.75	3.3	2.5	25.5	64.0	53.9	66.3	13.7	75.1
1.80	2.1	2.5	22.1	64.5	52.6	66.7	14.9	74.9
1.85	-0.8	2.5	19.3	63.4	49.5	65.4	12.8	74.4
1.90	0.6	2.5	17.2	62.8	49.3	64.7	12.5	73.9
1.95	-2.7	2.5	13.1	62.3	46.4	63.6	10.2	72.6
2.00	-4.9	2.5	10.3	61.8	45.1	63.4	9.2	72.6
2.05	-6.4	2.5	8.5	60.8	45.0	62.1	7.4	71.0
2.11	12.2	2.5	37.0	74.2	65.5	75.9	31.5	79.0
4TH PWR AVG	14.1	2.5	64.6	67.9	67.7	70.4	26.8	76.7

SECRET

[REDACTED]

VEHICLE 1174 TEMPERATURE DATA-ORBIT 1

ASCENDING NODE=ZERO PL TIME= 81388.2 SYSTEM TIME

PL TIME IN HRS.	FS-6	11-6	FS-5	11-7	28-2	11-8	28-1	11-9
0.60	74.2	80.0	68.9	76.8	107.2	80.1	96.0	79.5
0.65	82.7	79.6	68.5	76.6	117.8	78.8	96.4	79.7
0.70	95.3	79.9	74.5	76.6	129.9	78.6	98.2	79.9
0.75	104.5	78.7	76.2	76.3	138.5	77.5	100.3	79.8
0.80	115.0	79.1	76.0	76.2	145.3	77.8	97.7	80.9
0.85	123.8	79.1	80.2	76.5	152.0	77.2	96.1	81.8
0.90	132.6	79.2	83.4	76.5	156.9	77.2	98.4	82.3
0.95	139.5	79.5	89.2	76.6	158.9	77.8	101.9	83.3
1.00	145.6	80.0	96.6	76.9	161.8	78.4	106.2	84.8
1.05	150.6	80.1	103.7	77.3	161.3	79.0	111.0	85.6
1.10	151.2	80.2	111.3	77.4	157.6	78.4	113.5	86.2
1.15	148.4	79.9	117.6	77.1	151.9	78.2	116.8	85.8
1.20	147.1	80.4	123.5	77.5	147.4	79.1	123.1	87.0
1.25	143.1	80.9	131.1	77.3	139.6	79.4	127.5	88.1
1.30	128.4	80.9	121.9	77.7	127.1	79.3	119.7	87.0
1.35	112.5	81.6	108.8	77.6	116.6	78.9	108.6	86.4
1.40	99.1	80.6	97.8	76.9	104.2	78.6	98.8	86.4
1.45	90.4	81.8	91.2	77.7	96.4	78.5	93.9	86.0
1.50	82.1	82.7	84.0	78.4	88.8	79.3	89.3	85.6
1.55	72.7	81.9	75.3	77.1	79.8	78.4	82.5	83.7
1.60	68.4	81.3	72.4	76.8	74.9	77.8	81.2	83.4
1.65	60.3	81.0	65.0	76.9	69.9	77.5	75.2	82.8
1.70	55.7	81.0	62.7	76.8	63.7	76.4	72.4	81.6
1.75	49.9	80.1	59.3	76.3	57.7	75.7	69.6	80.4
1.80	45.2	80.5	53.5	76.1	54.8	75.1	66.6	79.5
1.85	42.2	80.4	50.9	75.7	50.4	74.6	63.7	79.0
1.90	41.3	79.6	52.4	75.7	54.8	74.1	74.6	78.4
1.95	41.7	78.8	53.3	74.8	60.7	72.9	81.9	76.5
2.00	45.1	78.7	54.5	75.1	70.0	72.6	87.3	76.1
2.05	48.6	78.0	53.8	74.1	79.4	71.6	89.2	75.1
2.11	74.2	80.0	68.9	76.8	107.2	80.1	96.0	79.5

4TH PWR AVG 98.9 80.2 83.5 76.7 113.6 77.4 95.4 82.5

VEHICLE 1174 TEMPERATURE DATA-ORBIT 1

ASCENDING NODE=ZERO PL TIME= 81388.2 SYSTEM TIME

PL TIME IN HRS.	11-11	11-10	SC-1	28-3	11-13	28-4	11-12	28-5
0.60	77.2	77.3	70.4	69.0	80.6	30.0	76.0	51.6
0.65	79.2	77.8	70.2	82.1	80.5	29.4	74.7	50.9
0.70	80.3	78.5	69.7	94.6	79.9	33.9	74.6	53.5
0.75	80.9	78.7	69.3	108.2	80.4	34.3	74.1	56.6
0.80	82.2	79.1	68.6	121.1	80.4	36.7	74.1	56.9
0.85	81.7	79.1	68.4	127.8	80.4	38.2	73.6	55.7
0.90	82.9	79.7	67.9	133.6	80.5	37.3	73.3	56.4
0.95	83.5	79.5	67.6	134.1	80.1	38.3	73.7	57.8
1.00	84.6	79.2	68.4	132.4	79.8	40.6	73.5	58.6
1.05	85.2	79.7	68.2	127.0	80.0	41.7	74.1	55.9
1.10	86.1	79.4	68.0	118.7	80.1	41.0	73.9	55.6
1.15	85.7	79.6	67.1	106.7	80.4	38.7	73.7	52.6
1.20	86.2	79.4	67.6	98.1	81.2	38.2	74.4	49.9
1.25	85.9	79.2	68.1	88.3	81.2	36.9	74.3	46.0
1.30	84.9	79.5	67.5	81.5	80.7	35.7	73.7	46.5
1.35	84.7	79.3	68.1	75.8	80.5	34.9	74.2	44.7
1.40	83.9	79.2	67.0	69.5	80.8	30.5	72.8	42.7
1.45	83.5	77.8	67.1	62.7	80.8	30.8	72.4	40.3
1.50	83.0	77.2	67.2	57.9	80.4	31.0	72.3	37.1
1.55	80.3	76.6	66.9	53.3	80.3	26.3	71.0	38.7
1.60	79.9	76.1	66.9	50.2	80.5	27.7	70.8	36.7
1.65	79.0	75.6	66.6	44.8	80.3	23.9	70.3	36.3
1.70	77.3	75.0	66.0	41.4	80.2	22.2	69.1	34.3
1.75	76.7	74.3	65.5	37.2	79.2	20.8	68.2	32.4
1.80	75.9	74.5	65.8	37.6	79.4	21.5	68.2	32.3
1.85	74.6	73.8	64.8	34.2	79.3	18.2	66.4	30.0
1.90	74.5	73.3	65.6	31.3	79.2	18.6	66.2	30.0
1.95	73.2	72.5	63.9	28.4	78.3	19.1	65.4	27.4
2.00	73.4	72.6	64.1	29.5	78.4	15.3	64.6	29.0
2.05	73.3	72.1	63.3	34.8	77.5	14.0	63.6	28.3
2.11	77.2	77.3	70.4	69.0	80.6	30.0	76.0	51.6
4TH PWR AVG	80.8	77.3	67.3	81.3	80.1	30.6	71.8	44.9

[REDACTED]

VEHICLE 1174 TEMPERATURE DATA-ORBIT 1

ASCENDING NODE=ZERO PL TIME= 81388.2 SYSTEM TIME

PL TIME IN HRS.	21-4	AI-1	21-3	CL-1	ITC-1	CL-2	+288U	21-5
0.60	85.0	84.7	82.6	95.5	64.9	91.4	28.2	80.7
0.65	84.4	86.7	82.5	95.1	64.2	88.5	28.1	79.4
0.70	83.8	89.0	82.4	94.9	63.2	90.3	28.2	79.3
0.75	83.9	93.6	82.6	94.3	62.9	89.9	28.2	79.5
0.80	84.8	95.5	83.2	96.0	63.1	89.7	28.2	79.1
0.85	84.4	100.7	83.5	95.9	62.5	90.1	28.2	79.1
0.90	84.7	103.8	83.9	95.1	62.5	89.0	28.1	78.4
0.95	85.0	106.2	84.0	95.3	61.8	88.5	28.2	79.1
1.00	85.3	111.5	84.7	94.2	62.1	88.3	28.1	79.1
1.05	85.7	114.4	84.6	94.0	62.0	89.4	28.2	79.9
1.10	86.3	118.3	84.9	94.3	61.8	88.7	28.1	79.5
1.15	87.1	122.2	85.3	95.6	61.2	88.3	28.2	80.3
1.20	88.2	123.3	86.0	95.4	60.9	89.9	28.2	80.6
1.25	87.9	124.9	85.8	93.8	60.2	88.5	28.2	79.8
1.30	88.2	118.7	86.4	94.4	59.8	88.1	28.2	80.2
1.35	88.2	112.5	85.9	94.9	59.3	89.4	28.2	80.4
1.40	88.3	105.4	86.5	94.9	58.9	88.0	28.2	80.4
1.45	87.8	99.5	85.3	93.6	57.3	88.4	28.2	79.7
1.50	86.7	92.5	85.4	93.4	56.9	88.0	28.2	79.6
1.55	86.5	90.3	85.1	93.1	56.1	87.8	28.2	79.1
1.60	85.5	85.6	84.2	92.7	55.6	86.7	28.2	78.5
1.65	85.6	82.1	83.4	90.6	53.9	86.4	28.1	78.0
1.70	83.7	79.1	82.5	91.7	53.5	84.3	28.2	77.7
1.75	82.6	73.5	81.3	89.6	53.2	84.4	28.2	77.3
1.80	81.9	75.1	80.4	89.9	51.6	83.5	28.2	77.6
1.85	80.5	71.3	80.3	88.5	51.0	82.8	28.2	76.2
1.90	80.0	71.1	78.8	88.8	49.7	82.4	28.2	76.3
1.95	78.6	71.5	77.8	87.7	48.4	81.8	28.2	74.7
2.00	77.6	73.0	77.5	86.6	47.4	80.8	28.2	75.2
2.05	76.5	73.0	77.0	86.2	46.7	78.9	28.2	74.0
2.11	85.0	84.7	82.6	95.5	64.9	91.4	28.2	80.7

4TH PWR AVG 84.7 95.9 83.2 93.0 58.2 87.3 28.2 78.7

SECRET

[REDACTED]

VEHICLE 1174 TEMPERATURE DATA-ORBIT 1

ASCENDING NODE=ZERO PL TIME= 81388.2 SYSTEM TIME

PL TIME IN HRS.	21-7	21-6	1TC-2	SC-2	-288U	1SI-2	21-8	1C-2
0.60	78.4	78.3	73.3	75.8	28.1	87.5	84.4	90.2
0.65	78.8	77.1	72.4	75.3	28.0	85.7	83.3	90.0
0.70	79.0	76.6	71.5	74.6	28.0	87.1	82.9	89.4
0.75	78.2	77.2	71.1	74.6	28.0	86.4	82.3	88.5
0.80	79.2	76.7	71.0	74.8	28.0	88.4	82.9	87.9
0.85	78.4	77.0	69.9	74.5	28.0	84.2	82.4	87.4
0.90	79.7	75.3	70.2	74.8	28.0	86.5	82.5	87.2
0.95	78.9	76.1	69.4	74.7	28.0	87.0	82.6	86.8
1.00	79.1	75.0	68.9	74.8	28.0	83.9	81.8	86.9
1.05	79.5	75.8	69.1	74.5	28.1	84.9	82.4	87.0
1.10	79.7	75.3	69.0	74.8	28.1	85.8	83.3	86.4
1.15	79.7	76.0	69.1	75.7	28.0	85.4	83.5	85.5
1.20	79.9	75.6	69.7	76.2	28.0	84.8	83.7	85.3
1.25	79.2	75.5	70.3	75.7	28.0	86.2	83.7	85.2
1.30	79.8	75.4	70.1	76.1	28.0	85.7	84.3	84.8
1.35	79.8	75.5	70.5	75.7	28.0	83.8	83.8	84.7
1.40	79.9	75.1	71.0	76.3	28.0	84.0	84.4	83.8
1.45	78.6	74.5	70.1	75.1	28.0	80.8	82.9	84.3
1.50	79.2	74.2	70.2	75.1	28.0	80.9	83.5	85.0
1.55	77.8	74.2	68.9	74.3	28.0	79.7	82.4	83.1
1.60	78.6	73.7	68.5	74.0	28.0	80.8	82.4	83.3
1.65	77.6	73.6	67.7	73.1	28.0	78.1	81.6	82.7
1.70	78.0	73.3	66.9	72.7	28.0	78.1	81.1	82.7
1.75	77.2	72.5	66.5	72.5	28.0	73.0	80.1	82.6
1.80	77.1	73.3	65.7	72.0	28.0	76.2	79.9	82.6
1.85	76.5	72.7	64.5	70.9	28.1	72.1	78.6	82.1
1.90	75.9	72.6	64.0	70.8	28.0	73.1	78.2	81.5
1.95	75.3	71.5	62.5	69.1	28.0	71.1	77.7	82.0
2.00	75.4	71.9	44.2	69.2	28.0	70.8	77.3	81.2
2.05	75.4	70.8	61.5	67.9	28.0	70.3	76.2	80.3
2.11	78.4	78.3	73.3	75.8	28.1	87.5	84.4	90.2

4TH PWR AVG 78.4 74.9 68.2 74.0 28.0 81.8 82.0 85.2

SECRET

[REDACTED]

VEHICLE 1174 TEMPERATURE DATA-ORBIT 1

ASCENDING NODE=ZERO PL TIME= 81388.2 SYSTEM TIME

PL TIME IN HRS.	21-11	21-9	+28C1	21-10	+28C2	-28C1	21-12	ZBAT
0.60	73.1	81.1	28.4	77.8	28.5	4.1	81.9	85.9
0.65	72.7	80.5	28.3	78.2	28.7	4.1	82.0	86.7
0.70	71.4	79.9	28.4	78.8	28.4	4.1	81.9	85.6
0.75	70.3	79.4	28.2	78.8	28.5	4.1	82.3	85.8
0.80	71.0	79.7	28.4	79.5	28.7	4.1	82.7	87.0
0.85	70.8	79.6	28.3	78.9	28.3	4.1	83.0	86.4
0.90	71.1	80.1	28.5	79.9	28.7	4.1	84.5	86.8
0.95	70.4	79.7	28.4	79.7	28.5	4.1	84.8	87.3
1.00	70.2	79.0	28.3	79.6	28.6	4.1	85.9	87.1
1.05	70.1	78.4	28.3	79.8	28.5	4.1	87.9	87.0
1.10	69.5	78.9	28.2	79.9	28.4	4.1	87.5	86.6
1.15	70.7	79.2	28.3	80.1	28.5	4.1	87.9	87.0
1.20	69.8	79.4	28.3	80.1	28.6	4.1	88.9	87.3
1.25	69.8	79.5	28.4	79.4	28.5	4.1	89.6	87.4
1.30	69.6	79.4	28.3	79.7	28.5	4.1	89.0	87.2
1.35	69.0	78.6	28.3	79.0	28.4	4.1	88.6	87.1
1.40	69.6	79.3	28.5	79.0	28.4	4.1	87.5	87.4
1.45	68.9	78.1	28.4	78.2	28.5	4.1	87.3	87.1
1.50	69.0	78.1	28.4	77.8	28.6	4.1	86.7	87.5
1.55	67.4	77.2	28.3	76.5	28.6	4.1	84.4	86.8
1.60	67.6	77.4	28.4	76.4	28.7	4.1	83.7	87.8
1.65	67.7	77.1	28.6	76.1	28.7	4.1	82.5	87.9
1.70	67.4	76.4	28.3	75.7	28.6	4.1	81.7	87.9
1.75	66.3	75.3	28.3	74.2	28.5	4.1	80.8	87.8
1.80	65.1	75.0	28.3	74.3	28.3	4.1	79.6	87.5
1.85	65.2	74.2	28.3	73.4	28.5	4.1	78.2	87.9
1.90	64.8	74.2	28.4	73.1	28.4	4.1	76.9	87.5
1.95	63.9	73.0	28.3	73.2	28.6	4.1	75.8	87.7
2.00	63.5	72.6	28.3	73.0	28.5	4.1	75.3	87.9
2.05	63.2	71.8	28.4	73.0	28.5	4.1	73.3	87.4
2.11	73.1	81.1	28.4	77.8	28.5	4.1	81.9	85.9

4TH PWR AVG 68.8 77.9 28.4 77.5 28.5 4.1 83.6 87.1

VEHICLE 1174 TEMPERATURE DATA-ORBIT 1

ASCENDING NODE=ZERO PL TIME= 81388.2 SYSTEM TIME

PL TIME IN HRS.	21-13	-28C2
0.60	78.7	4.0
0.65	77.7	4.1
0.70	78.2	4.0
0.75	78.1	4.1
0.80	77.5	4.1
0.85	77.8	4.1
0.90	76.5	4.1
0.95	77.1	4.1
1.00	76.4	4.1
1.05	76.7	4.1
1.10	76.8	4.0
1.15	76.7	4.1
1.20	76.8	4.1
1.25	76.2	4.1
1.30	76.5	4.1
1.35	76.3	4.0
1.40	76.3	4.1
1.45	76.2	4.0
1.50	76.2	4.1
1.55	75.3	4.0
1.60	76.1	4.1
1.65	75.3	4.1
1.70	75.1	4.1
1.75	75.5	4.1
1.80	75.1	4.0
1.85	74.8	4.1
1.90	74.9	4.1
1.95	74.6	4.1
2.00	74.1	4.0
2.05	73.6	4.1
2.11	78.7	4.0

4TH PWR AVG 76.3 4.1

[REDACTED]

VEHICLE 1174 TEMPERATURE DATA-ORBIT 22

ASCENDING NODE=ZERO PL TIME= 23107.0 SYSTEM TIME

PL TIME IN HRS.	FS-2	HALF	FS-1	11-3	FS-4	11-4	FS-3	11-5
0.05	-8.6	2.5	21.1	43.2	38.0	46.1	-1.8	55.2
0.10	-14.1	2.5	15.4	43.1	35.7	46.3	-5.5	55.5
0.15	-13.0	2.5	9.3	43.3	33.1	46.5	-5.2	55.5
0.20	-16.0	2.5	5.5	43.4	30.7	45.9	-7.2	55.3
0.25	-16.7	2.5	2.3	43.3	29.3	46.8	-5.7	55.4
0.30	-19.6	2.5	2.2	43.7	28.0	45.5	-8.8	55.2
0.35	-21.5	2.5	-2.0	43.0	25.9	44.7	-9.2	54.6
0.40	-19.6	2.5	-3.8	41.8	24.7	44.4	-10.5	53.9
0.45	-23.2	2.5	-7.2	41.2	25.0	43.7	-10.5	53.3
0.50	-25.7	2.5	-9.2	41.1	24.5	43.5	-10.2	52.7
0.55	-22.7	2.5	-4.7	41.1	28.3	44.2	-7.4	52.8
0.60	-22.9	2.5	3.3	40.9	30.8	45.1	-1.7	52.8
0.65	-20.0	2.5	15.4	40.9	34.1	44.6	-2.6	52.4
0.70	-19.3	2.5	29.5	41.3	35.1	45.3	3.6	52.5
0.75	-17.8	2.5	47.4	40.2	38.1	44.5	6.7	52.9
0.80	-12.5	2.5	62.6	40.4	39.7	44.5	6.7	52.3
0.85	-9.1	2.5	77.1	40.4	41.6	44.6	6.6	51.9
0.90	-3.1	2.4	85.6	40.5	40.3	44.8	7.2	52.0
0.95	1.4	2.5	95.1	40.5	40.6	44.7	8.6	52.6
1.00	3.3	2.5	101.2	41.1	43.8	45.5	8.9	52.7
1.05	3.9	2.5	100.9	41.1	43.2	45.6	9.0	53.3
1.10	5.6	2.5	97.1	41.8	44.9	46.1	7.8	53.2
1.15	5.6	2.5	90.4	42.2	48.8	46.4	6.4	53.8
1.20	5.2	2.5	79.7	41.9	54.7	46.7	6.5	55.0
1.25	1.7	2.5	68.7	42.1	60.4	46.2	6.1	55.6
1.30	-2.4	2.5	58.9	42.9	53.5	46.9	2.6	55.6
1.35	-1.4	2.5	50.6	42.8	50.2	47.2	1.4	55.2
1.40	-4.3	2.4	41.9	42.8	43.9	47.0	1.2	55.2
1.45	-5.8	2.5	35.5	42.8	43.8	46.9	1.1	55.7
1.50	-7.2	2.5	30.9	43.4	41.8	46.0	0.7	56.0
1.56	-8.6	2.5	21.1	43.2	38.0	46.1	-1.8	55.2
4TH PWR AVG	-9.8	2.5	43.7	41.9	38.6	45.5	0.2	54.0

[REDACTED]

VEHICLE 1174 TEMPERATURE DATA-ORBIT 22

ASCENDING NODE=ZERO PL TIME= 23107.0 SYSTEM TIME

PL TIME IN HRS.	FS-6	11-6	FS-5	11-7	28-2	11-8	28-1	11-9
0.05	51.9	64.7	53.2	61.5	64.0	56.0	65.7	67.4
0.10	45.1	64.6	47.3	61.2	56.6	57.2	62.0	67.3
0.15	38.3	64.9	43.4	61.2	49.2	57.3	58.6	66.3
0.20	33.4	64.5	39.4	60.9	44.7	56.6	54.2	66.0
0.25	30.1	64.9	36.3	60.7	43.0	57.1	52.8	65.7
0.30	27.0	64.0	33.7	60.6	40.5	56.9	51.2	65.4
0.35	23.7	63.7	33.9	60.3	40.2	55.2	56.3	64.0
0.40	23.7	63.2	34.0	59.7	47.2	54.9	66.6	63.6
0.45	25.7	62.8	32.1	59.2	54.5	54.6	71.3	61.5
0.50	28.7	63.3	33.9	58.3	64.2	53.6	74.6	60.8
0.55	36.5	64.5	35.9	58.7	75.0	53.7	74.6	60.2
0.60	45.1	63.9	36.3	59.4	85.1	54.3	74.7	61.1
0.65	55.6	62.9	39.8	59.6	98.2	53.2	75.4	61.6
0.70	65.7	62.1	39.7	59.5	109.3	52.7	74.3	60.7
0.75	78.4	61.9	45.7	59.9	118.9	52.9	76.8	61.7
0.80	89.3	62.0	47.9	60.0	130.1	52.5	76.7	61.5
0.85	100.1	61.5	50.8	59.9	136.9	53.0	78.6	62.5
0.90	108.7	62.1	54.7	60.2	143.7	52.8	80.2	64.0
0.95	119.9	61.6	62.1	59.3	145.9	53.4	79.9	65.1
1.00	126.1	61.5	66.1	59.8	149.1	53.6	85.1	66.2
1.05	131.1	61.6	74.5	59.9	148.6	54.8	88.0	66.5
1.10	131.2	62.3	84.5	60.1	144.4	55.1	93.3	67.8
1.15	132.4	62.6	92.6	59.7	138.8	55.1	98.2	68.0
1.20	129.1	62.9	101.9	60.0	133.6	56.4	103.8	69.1
1.25	122.9	63.2	109.1	60.4	123.8	56.0	109.8	69.1
1.30	105.4	63.9	95.6	60.1	112.3	57.2	100.3	69.5
1.35	92.4	63.4	85.0	60.7	98.8	56.8	88.9	69.8
1.40	79.9	63.9	75.8	60.6	90.3	57.2	82.3	68.7
1.45	71.7	64.0	69.8	60.2	82.4	56.9	76.1	67.6
1.50	63.0	63.8	64.0	60.7	75.1	56.9	73.9	67.4
1.56	51.9	64.7	53.2	61.5	64.0	56.0	65.7	67.4

4TH PWR AVG 77.4 63.2 58.5 60.1 98.1 55.2 77.1 65.2

[REDACTED]

VEHICLE 1174 TEMPERATURE DATA-ORBIT 22

ASCENDING NODE=ZERO PL TIME= 23107.0 SYSTEM TIME

PL TIME IN HRS.	11-11	11-10	5C-1	2B-3	11-13	2B-4	11-12	2B-5
0.05	60.3	60.7	54.2	35.6	61.1	9.7	50.2	18.9
0.10	60.8	60.4	53.2	32.1	61.9	10.0	50.2	17.7
0.15	60.6	60.5	52.5	27.0	62.2	6.3	49.7	16.7
0.20	60.2	59.9	53.4	23.0	61.9	4.5	49.9	17.2
0.25	60.4	59.2	53.5	21.9	62.6	5.4	49.8	18.4
0.30	59.6	59.0	52.7	21.3	62.0	4.6	49.1	14.9
0.35	58.4	58.9	52.5	18.0	61.9	3.1	48.7	14.7
0.40	57.9	58.7	52.0	14.7	61.1	1.3	48.4	13.5
0.45	55.8	57.9	51.1	16.8	60.0	0.3	46.9	14.4
0.50	54.0	57.1	51.6	21.4	59.2	-0.7	45.9	14.8
0.55	54.7	57.8	51.9	33.0	59.4	-0.0	46.7	19.5
0.60	56.9	58.7	51.6	47.1	58.9	1.7	47.0	24.0
0.65	57.3	60.0	51.5	62.3	59.6	3.2	47.0	24.4
0.70	58.0	59.6	51.1	75.6	59.2	5.9	47.0	26.6
0.75	59.2	60.8	50.7	91.8	58.9	9.3	47.3	28.1
0.80	59.9	60.8	51.3	105.1	58.9	11.9	47.0	29.0
0.85	61.2	61.0	50.6	113.8	58.8	15.5	47.4	30.9
0.90	61.6	61.1	51.0	121.9	59.5	19.1	48.4	31.5
0.95	62.2	61.6	51.3	123.1	59.3	20.6	49.2	32.4
1.00	63.0	61.4	51.1	122.5	59.6	22.0	49.4	32.7
1.05	63.9	61.4	50.6	115.4	60.1	21.0	50.2	31.8
1.10	64.5	61.8	51.4	108.2	59.7	23.3	50.2	31.5
1.15	64.6	61.5	52.2	96.3	60.0	21.5	50.8	30.2
1.20	64.9	61.0	51.8	83.8	60.2	18.7	51.6	27.2
1.25	64.4	61.2	51.9	75.5	60.2	19.4	50.7	25.6
1.30	65.1	62.0	52.2	68.0	60.7	17.9	50.2	23.8
1.35	64.6	61.0	51.9	59.4	60.9	15.8	51.5	22.2
1.40	63.3	61.0	52.1	54.8	60.6	15.8	51.2	23.5
1.45	63.4	61.1	52.5	49.6	60.5	14.1	51.2	24.1
1.50	62.4	59.9	52.5	44.5	60.2	12.5	50.4	22.3
1.56	60.3	60.7	54.2	35.6	61.1	9.7	50.2	18.9

4TH PWR AVG 60.8 60.3 52.0 66.2 60.3 11.2 49.1 23.4

SECRET

[REDACTED]

VEHICLE 1174 TEMPERATURE DATA-ORBIT 22

ASCENDING NODE=ZERO PL TIME= 23107.0 SYSTEM TIME

PL TIME IN HRS.	21-4	AI-1	2I-3	CL-1	1TC-1	CL-2	+28BU	21-5
0.05	67.3	73.3	65.1	71.3	24.0	64.0	28.2	58.7
0.10	67.5	70.1	65.0	69.3	23.6	63.1	28.2	59.4
0.15	66.5	66.9	64.5	69.1	23.8	64.2	28.2	59.0
0.20	66.0	64.1	63.7	68.9	23.2	63.4	28.2	59.5
0.25	66.0	61.5	63.4	69.2	21.7	65.9	28.2	59.2
0.30	66.2	59.4	62.9	68.9	22.5	63.1	28.2	58.8
0.35	64.6	59.2	62.1	70.0	21.7	62.7	28.2	58.1
0.40	63.4	61.0	61.7	69.5	21.0	62.9	28.2	57.4
0.45	62.0	60.9	60.7	68.0	19.8	62.1	28.1	56.5
0.50	61.2	61.8	60.2	68.1	19.1	61.9	28.1	56.4
0.55	61.6	62.9	60.2	68.4	18.6	61.7	28.2	56.3
0.60	61.9	64.8	61.2	68.5	18.8	61.9	28.2	56.3
0.65	62.9	65.8	60.8	69.9	19.4	63.0	28.2	55.9
0.70	62.1	69.1	61.1	68.3	19.2	61.8	28.2	55.6
0.75	62.4	73.6	61.1	69.1	19.9	62.5	28.2	55.5
0.80	62.5	76.2	61.1	68.8	20.4	62.1	28.2	55.5
0.85	62.9	80.2	62.1	68.9	20.8	63.3	28.2	56.1
0.90	64.4	84.2	62.5	68.6	21.1	63.7	28.2	56.6
0.95	64.1	87.3	63.2	70.3	22.1	63.9	28.2	56.5
1.00	64.9	93.9	63.3	69.4	21.8	63.3	28.2	56.8
1.05	65.2	96.3	63.3	69.5	22.8	63.5	28.2	57.5
1.10	66.2	102.7	64.9	70.2	23.1	64.6	28.2	58.7
1.15	66.8	105.1	64.9	70.0	23.0	65.4	28.2	58.4
1.20	67.2	108.4	65.0	69.7	23.2	65.2	28.2	59.2
1.25	67.7	109.8	65.2	70.4	23.9	66.3	28.2	59.4
1.30	68.9	103.9	65.8	72.4	23.7	66.5	28.2	59.6
1.35	68.1	96.6	65.2	72.4	24.9	66.9	28.2	60.1
1.40	68.7	89.6	65.5	72.3	23.8	66.3	28.2	59.9
1.45	67.8	85.1	65.6	71.9	23.5	65.8	28.2	59.8
1.50	67.9	81.0	64.8	71.9	23.7	66.0	28.2	59.5
1.56	67.3	73.3	65.1	71.3	24.0	64.0	28.2	58.7
4TH PWR AVG	65.2	79.7	63.2	69.7	22.0	63.9	28.2	57.9

~~SECRET~~

[REDACTED]

VEHICLE 1174 TEMPERATURE DATA-ORBIT 22

ASCENDING NODE=ZERO PL TIME= 23107.0 SYSTEM TIME

PL TIME IN HRS.	21-7	21-6	1TC-2	SC-2	-28BU	1S1-2	21-8	1C-2
0.05	61.9	55.2	33.5	58.7	28.0	41.7	63.0	44.6
0.10	61.6	55.4	33.0	58.3	28.0	42.6	63.3	44.3
0.15	61.8	54.5	32.7	58.3	28.0	40.9	63.1	43.6
0.20	61.6	54.9	32.5	57.4	28.0	40.4	63.6	44.4
0.25	63.0	55.1	32.6	57.5	28.0	41.2	63.3	45.1
0.30	61.7	54.8	32.6	57.2	28.0	40.6	62.1	44.9
0.35	61.1	54.7	31.8	56.0	28.0	37.5	61.8	44.6
0.40	60.7	54.4	30.9	55.4	28.0	37.1	60.8	44.4
0.45	60.0	54.6	29.9	54.8	28.0	36.6	60.3	44.9
0.50	59.7	55.6	29.8	54.2	28.0	37.2	59.5	45.8
0.55	60.4	56.8	29.4	54.9	28.0	38.8	60.6	48.9
0.60	60.1	55.8	28.5	54.2	28.0	39.1	60.1	50.0
0.65	60.5	54.9	28.6	53.8	28.0	41.3	59.9	49.2
0.70	60.3	54.9	27.8	53.9	28.0	39.8	59.3	48.3
0.75	61.3	53.6	27.9	53.5	28.0	41.3	59.6	48.4
0.80	61.6	53.7	27.5	54.0	28.0	41.0	59.9	47.2
0.85	61.3	53.6	27.3	54.4	28.0	42.0	59.2	47.1
0.90	61.5	53.7	27.9	54.7	28.0	42.0	59.2	46.4
0.95	62.0	53.7	28.1	54.4	28.0	42.5	60.6	45.3
1.00	61.3	53.7	28.0	54.9	28.0	42.5	60.4	46.5
1.05	62.0	54.0	27.7	55.5	28.0	42.9	60.7	45.2
1.10	62.4	53.6	29.0	56.3	28.0	43.6	61.6	45.9
1.15	62.3	53.7	29.7	56.4	28.0	42.2	62.3	45.4
1.20	61.6	53.6	30.3	56.6	28.0	43.3	62.5	44.7
1.25	62.3	53.9	30.8	57.3	28.0	45.2	63.0	45.1
1.30	61.8	54.6	31.5	58.0	28.0	42.3	63.0	45.5
1.35	61.9	54.0	31.9	58.2	28.0	42.7	63.4	45.0
1.40	61.5	54.5	32.4	58.1	28.0	43.7	63.7	44.8
1.45	61.6	54.4	32.8	58.2	28.0	43.0	64.1	44.1
1.50	61.8	54.4	32.8	57.8	28.0	43.1	64.0	44.3
1.56	61.9	55.2	33.5	58.7	28.0	41.7	63.0	44.6

4TH PWR AVG 61.4 54.5 30.3 56.1 28.0 41.3 61.6 45.8

[REDACTED]

VEHICLE 1174 TEMPERATURE DATA-ORBIT 22

ASCENDING NODE=ZERO PL TIME= 23107.0 SYSTEM TIME

PL TIME IN HRS.	21-11	21-9	+28C1	21-10	+28C2	-28C1	21-12	2BAT
0.05	47.5	54.5	28.5	60.8	28.7	4.1	65.7	64.2
0.10	49.2	54.7	28.5	60.2	28.6	4.1	65.9	64.0
0.15	49.5	55.3	28.5	60.3	28.6	4.1	64.4	64.0
0.20	50.0	54.6	28.5	59.9	28.7	4.1	63.8	63.8
0.25	50.2	54.9	28.7	59.9	28.7	4.1	63.7	65.0
0.30	49.4	55.2	28.6	58.9	28.7	4.1	62.6	65.1
0.35	49.4	53.7	28.6	58.8	28.7	4.1	61.7	65.5
0.40	49.1	53.6	28.5	58.3	28.7	4.1	60.8	65.1
0.45	49.4	52.8	28.6	58.4	28.7	4.1	59.6	64.0
0.50	49.0	52.2	28.5	57.3	28.8	4.1	58.3	63.6
0.55	49.0	52.9	28.7	58.6	28.7	4.1	59.7	64.0
0.60	49.1	52.3	28.5	59.0	28.7	4.1	59.1	64.9
0.65	48.8	52.9	28.7	59.7	28.9	4.1	59.6	64.7
0.70	48.8	52.4	28.7	61.1	28.7	4.1	60.2	64.3
0.75	49.3	52.1	28.5	60.9	28.7	4.1	60.1	64.8
0.80	49.2	52.5	28.7	61.3	28.6	4.1	61.0	64.1
0.85	49.2	52.0	28.5	61.9	28.6	4.1	61.8	65.0
0.90	49.1	52.8	28.6	62.2	28.7	4.1	63.7	64.1
0.95	49.6	53.2	28.4	62.2	28.6	4.1	63.6	64.8
1.00	50.6	54.1	28.7	62.4	28.7	4.1	65.5	65.4
1.05	50.2	54.4	28.8	62.0	28.5	4.1	66.6	64.8
1.10	50.6	54.4	28.6	62.8	28.6	4.2	67.3	65.4
1.15	51.1	55.3	28.7	61.8	28.7	4.1	67.8	64.8
1.20	50.7	54.6	28.8	61.6	28.7	4.1	68.7	65.1
1.25	51.8	55.4	28.5	62.7	28.6	4.1	68.6	64.9
1.30	51.6	55.9	28.7	61.9	28.7	4.1	69.8	65.6
1.35	51.5	56.0	28.5	61.7	28.7	4.1	68.4	65.3
1.40	51.3	56.0	28.7	61.5	28.6	4.1	68.6	64.7
1.45	51.5	55.3	28.6	61.2	28.6	4.1	68.2	65.0
1.50	51.3	56.3	28.6	61.0	28.6	4.1	66.9	64.9
1.56	47.5	54.5	28.5	60.8	28.7	4.1	65.7	64.2

4TH PWR AVG 49.9 54.1 28.6 60.7 28.7 4.1 64.1 64.7

[REDACTED]

VEHICLE 1174 TEMPERATURE DATA-ORBIT 22

ASCENDING NODE=ZERO PL TIME= 23107.0 SYSTEM TIME

PL TIME IN HRS.	21-13	-28C2
0.05	57.8	4.1
0.10	58.2	4.1
0.15	58.6	4.1
0.20	59.1	4.1
0.25	59.0	4.1
0.30	58.9	4.1
0.35	58.5	4.1
0.40	57.9	4.1
0.45	57.9	4.1
0.50	56.8	4.1
0.55	57.3	4.1
0.60	57.2	4.1
0.65	57.4	4.1
0.70	57.1	4.1
0.75	56.4	4.1
0.80	57.0	4.1
0.85	56.6	4.1
0.90	56.7	4.1
0.95	56.7	4.1
1.00	56.4	4.1
1.05	56.9	4.1
1.10	56.9	4.1
1.15	56.7	4.0
1.20	56.8	4.1
1.25	57.7	4.1
1.30	57.5	4.1
1.35	57.4	4.1
1.40	57.4	4.1
1.45	57.7	4.1
1.50	57.8	4.1
1.56	57.8	4.1

4TH PWR AVG 57.5 4.1

[REDACTED]

VEHICLE 1174 TEMPERATURE DATA-ORBIT 39

ASCENDING NODE=ZERO PL TIME= 29405.2 SYSTEM TIME

PL TIME IN HRS.	FS-2	HALF	FS-1	11-3	FS-4	11-4	FS-3	11-5
0.30	-16.4	2.5	6.4	40.9	29.1	42.7	-7.0	52.8
0.35	-16.1	2.5	2.4	41.7	29.2	43.3	-7.0	52.8
0.40	-19.0	2.5	-1.2	41.2	26.0	43.3	-9.2	53.0
0.45	-20.2	2.5	-3.1	40.8	22.7	43.2	-10.8	52.8
0.50	-20.2	2.5	-7.0	41.6	22.4	42.8	-10.9	51.9
0.55	-24.2	2.5	-10.8	40.2	20.1	42.0	-12.3	51.2
0.60	-24.7	2.5	-11.6	39.4	22.7	43.1	-8.9	50.8
0.65	-23.3	2.5	-2.9	40.3	26.7	43.3	-6.7	51.4
0.70	-23.5	2.5	6.5	40.1	32.7	43.7	-0.5	51.4
0.75	-20.0	2.5	22.5	40.0	32.2	44.6	3.4	51.5
0.80	-19.1	2.5	38.1	39.8	34.2	44.1	2.0	50.4
0.85	-12.5	2.5	57.5	39.1	36.5	43.9	3.2	50.9
0.90	-6.1	2.5	74.3	39.6	38.6	44.3	5.4	51.7
0.95	-2.3	2.5	88.0	39.8	38.9	44.3	6.3	50.9
1.00	3.7	2.5	98.5	39.8	40.6	44.3	8.0	52.1
1.05	7.2	2.5	101.9	40.0	41.4	44.7	12.2	51.8
1.10	9.1	2.5	102.9	40.3	43.1	45.5	9.5	52.5
1.15	10.5	2.5	100.9	40.9	43.2	45.7	9.5	53.1
1.20	7.7	2.5	90.4	41.1	49.5	45.9	7.8	52.8
1.25	6.4	2.5	76.8	41.3	56.1	46.3	5.9	53.5
1.30	3.7	2.5	65.9	42.1	56.7	46.6	4.7	54.1
1.35	-0.2	2.5	53.6	42.2	47.2	45.8	1.3	54.7
1.40	0.1	2.5	47.7	42.5	45.5	45.8	1.5	54.4
1.45	-3.8	2.5	38.4	43.7	43.5	46.6	1.5	55.1
1.50	-7.4	2.5	29.3	42.2	38.9	46.3	-1.2	54.4
1.55	-8.8	2.5	24.6	43.7	39.1	46.4	1.6	55.0
1.60	-16.0	2.5	17.2	42.5	35.7	46.0	-3.1	54.0
1.81	-16.4	2.5	6.4	40.9	29.1	42.7	-7.0	52.8

4TH PWR AVG -9.1 2.5 41.4 41.0 36.1 44.4 -0.5 52.6

SECRET

[REDACTED]

VEHICLE 1174 TEMPERATURE DATA-ORBIT 39

ASCENDING NOCZ=ZERO PL TIME= 29405.2 SYSTEM TIME

PL TIME IN HRS.	FS-6	11-6	FS-5	11-7	2B-2	11-8	2B-1	11-9
0.30	31.1	61.1	35.5	58.2	42.9	53.2	52.0	63.6
0.35	28.9	61.6	34.3	58.6	41.6	54.2	50.2	63.0
0.40	23.7	61.8	29.5	58.9	37.1	53.9	45.2	63.1
0.45	20.3	61.2	28.5	58.8	34.8	53.4	50.5	61.8
0.50	20.3	61.0	30.8	58.3	41.0	53.7	60.4	62.1
0.55	18.8	60.7	25.6	57.3	52.0	52.2	64.9	59.2
0.60	22.0	61.8	26.5	57.4	59.7	52.3	66.1	58.6
0.65	32.5	62.5	31.1	57.5	73.3	52.5	69.7	58.0
0.70	42.9	61.9	35.1	58.4	85.1	52.7	70.5	59.4
0.75	53.3	61.2	33.1	58.5	97.6	52.3	68.6	59.7
0.80	66.9	61.1	36.5	57.5	109.1	51.9	69.4	59.7
0.85	78.4	60.4	38.9	58.4	119.1	51.9	70.3	60.9
0.90	92.4	60.8	40.7	58.7	128.0	51.8	70.6	61.5
0.95	102.2	59.8	45.0	59.1	136.6	52.3	71.8	62.3
1.00	111.8	60.6	52.5	58.5	138.4	52.4	73.9	63.6
1.05	118.3	60.0	59.4	58.6	141.3	52.8	77.2	64.0
1.10	124.3	59.9	69.7	59.4	140.7	53.7	82.5	65.7
1.15	127.2	60.8	78.3	59.2	138.4	53.7	87.1	66.2
1.20	124.9	60.8	88.2	59.1	131.5	54.8	92.1	66.6
1.25	122.3	60.8	96.9	59.5	121.7	55.3	98.0	67.4
1.30	112.6	61.3	95.4	60.0	111.2	55.4	96.4	67.9
1.35	93.9	61.0	81.9	59.4	99.1	55.3	85.0	67.4
1.40	80.8	62.1	72.9	60.0	88.4	55.7	79.3	67.2
1.45	70.4	62.0	66.4	59.0	80.6	56.7	74.8	65.7
1.50	61.2	61.4	57.8	59.1	72.8	55.6	69.2	66.3
1.55	54.0	62.0	52.8	59.3	66.3	56.2	66.6	65.4
1.60	46.0	60.8	48.1	59.1	58.1	55.4	62.6	64.7
1.81	31.1	61.1	35.5	58.2	42.9	53.2	52.0	63.6
4TH PWR AVG	69.3	61.2	50.9	58.7	89.0	53.7	69.5	63.4

[REDACTED]

VEHICLE 1174 TEMPERATURE DATA-ORBIT 39

ASCENDING NODE=ZERO PL TIME= 29405.2 SYSTEM TIME

PL TIME IN HRS.	11-11	11-10	SC-1	28-3	11-13	28-4	11-12	28-5
0.30	56.2	57.8	52.0	22.8	58.1	4.4	47.8	18.0
0.35	56.6	58.2	53.0	21.1	59.0	6.0	48.1	18.3
0.40	56.3	57.4	52.8	16.7	58.7	4.1	47.4	16.7
0.45	55.7	57.0	52.2	15.0	58.7	1.8	46.7	14.7
0.50	56.1	57.2	52.5	13.8	59.3	2.0	46.9	13.4
0.55	52.4	56.6	51.3	14.9	57.3	0.9	45.6	15.6
0.60	52.3	56.0	51.5	22.8	57.0	0.5	45.7	16.4
0.65	52.4	57.0	51.8	35.2	57.1	1.8	46.3	21.7
0.70	54.9	58.2	52.0	53.1	57.2	5.2	47.1	26.4
0.75	55.7	58.8	51.4	69.7	57.5	8.1	46.9	27.4
0.80	56.8	59.5	50.5	86.7	56.5	10.2	46.0	28.4
0.85	57.6	59.6	51.0	101.5	57.2	15.4	46.8	30.0
0.90	59.4	60.5	51.3	115.3	58.0	19.1	48.1	31.9
0.95	59.7	60.2	50.6	123.1	57.7	23.6	48.2	32.4
1.00	61.2	61.2	51.1	125.9	58.0	26.2	48.9	33.4
1.05	61.0	60.1	51.2	124.6	57.4	27.7	49.1	37.7
1.10	62.8	61.1	51.7	118.5	57.4	27.2	50.1	36.9
1.15	63.3	61.3	51.5	107.9	58.2	27.5	50.3	33.3
1.20	62.7	60.5	51.9	93.7	58.1	25.0	50.7	31.1
1.25	63.0	59.9	52.8	80.7	58.1	22.4	50.8	29.0
1.30	63.3	60.3	52.9	72.3	58.3	21.2	51.5	26.8
1.35	63.1	60.5	52.5	63.4	58.6	17.2	51.3	25.0
1.40	62.6	60.9	52.8	57.3	59.5	17.4	52.1	24.2
1.45	55.9	59.4	52.5	52.7	57.9	17.0	52.1	25.8
1.50	53.0	59.0	53.1	45.8	56.8	16.5	50.8	25.0
1.55	52.6	58.8	52.7	41.7	56.4	14.8	50.9	24.5
1.60	50.4	58.6	52.5	36.3	56.1	11.2	50.2	23.3
1.81	56.2	57.8	52.0	22.8	58.1	4.4	47.8	18.0
4TH PWR AVG	57.7	59.0	52.0	63.7	57.9	13.1	48.6	24.7

[REDACTED]

VEHICLE 1174 TEMPERATURE DATA-ORBIT 39

ASCENDING NODE=ZERO PL TIME= 29405.2 SYSTEM TIME

PL TIME IN HRS.	21-4	AI-1	21-3	CL-1	1TC-1	CL-2	+288U	21-5
0.30	62.8	60.1	60.5	67.9	20.2	62.0	28.2	56.7
0.35	63.2	59.0	60.6	68.6	19.9	63.1	28.2	56.8
0.40	62.9	58.1	60.7	69.5	19.4	63.1	28.2	57.0
0.45	61.9	53.7	59.6	68.2	19.1	62.5	28.2	56.5
0.50	61.7	55.2	59.3	68.4	18.0	62.9	28.2	56.6
0.55	60.0	55.5	57.8	66.1	17.2	61.9	28.1	55.4
0.60	60.5	55.5	58.0	67.3	15.8	61.6	28.1	55.1
0.65	60.2	57.1	58.5	66.8	16.2	61.1	28.1	55.0
0.70	61.2	60.2	58.8	68.3	17.3	62.4	28.2	55.3
0.75	61.3	62.2	59.0	67.8	17.6	62.1	28.2	55.1
0.80	61.6	63.9	58.6	67.1	16.9	61.6	28.2	55.8
0.85	62.0	67.6	59.2	67.7	17.8	61.2	28.2	55.7
0.90	62.5	73.3	60.3	68.4	19.0	62.1	28.2	55.8
0.95	62.1	78.1	59.7	68.2	19.3	62.9	28.2	55.8
1.00	63.3	79.8	60.7	67.1	18.9	60.8	28.2	56.3
1.05	63.2	87.7	60.7	69.5	20.7	63.6	28.2	56.6
1.10	63.9	93.5	60.7	70.5	21.6	63.6	28.2	56.5
1.15	64.9	96.9	62.1	70.4	21.9	64.2	28.2	57.3
1.20	65.3	99.0	61.9	69.2	21.1	65.1	28.2	57.6
1.25	65.8	104.6	62.2	70.6	21.9	64.8	28.2	57.7
1.30	66.5	100.2	62.3	70.1	21.6	65.5	28.2	58.7
1.35	66.4	92.7	63.0	70.4	21.6	64.2	28.2	58.5
1.40	66.9	86.5	63.9	71.3	22.2	64.9	28.2	59.1
1.45	67.1	82.8	63.4	72.1	22.2	66.4	28.2	59.7
1.50	65.8	75.5	62.0	70.5	21.5	65.8	28.2	58.2
1.55	65.7	77.0	62.4	72.6	22.1	67.3	28.2	58.8
1.60	64.7	69.3	61.6	71.3	21.3	65.0	28.2	58.2
1.81	62.8	60.1	60.5	67.9	20.2	62.0	28.2	56.7
4TH PWR AVG	63.4	73.2	60.6	69.0	19.7	63.3	28.2	56.8

SECRET

[REDACTED]

VEHICLE 1174 TEMPERATURE DATA-ORBIT 39

ASCENDING NODE-ZERO PL TIME= 29405.2 SYSTEM TIME

PL TIME IN HRS.	21-7	21-6	1TC-2	SC-2	-288U	1SI-2	21-8	1C-2
0.30	59.7	52.7	28.2	56.6	28.0	37.2	61.1	42.4
0.35	60.1	53.1	28.5	56.4	28.0	37.4	61.0	43.6
0.40	60.3	53.6	28.0	55.9	28.0	36.8	61.0	42.8
0.45	60.3	53.3	28.3	55.3	28.0	36.7	60.5	43.7
0.50	59.9	53.3	27.1	54.9	28.0	36.1	60.3	43.8
0.55	58.7	53.3	26.1	54.0	28.0	36.4	59.2	43.7
0.60	58.9	55.3	25.8	53.6	27.9	35.1	59.2	46.1
0.65	58.8	56.7	25.9	53.1	28.0	38.4	59.9	50.0
0.70	60.2	55.3	25.2	53.8	28.0	39.2	59.7	51.9
0.75	60.1	54.7	25.0	52.5	28.0	39.9	59.5	50.9
0.80	60.1	54.4	24.6	52.7	27.9	38.3	58.2	49.5
0.85	60.9	53.7	25.2	52.4	28.0	38.9	58.8	48.6
0.90	61.2	53.6	24.6	53.6	28.0	40.1	58.9	47.7
0.95	61.5	53.5	24.2	53.8	28.0	40.0	58.9	47.3
1.00	61.4	53.2	24.9	53.5	28.0	41.2	59.9	47.2
1.05	61.0	52.8	24.9	54.1	28.0	42.3	59.1	46.2
1.10	61.7	53.4	25.4	55.1	28.0	41.7	60.2	46.7
1.15	61.4	53.4	25.9	55.4	28.0	41.2	61.0	45.7
1.20	61.9	53.6	26.5	56.3	28.0	41.7	61.0	45.6
1.25	61.5	53.1	26.5	56.9	28.0	42.2	61.5	45.2
1.30	61.7	53.8	28.2	57.1	28.0	44.2	62.5	45.5
1.35	61.6	53.7	28.5	56.7	28.0	39.8	62.9	44.4
1.40	61.4	55.0	29.3	56.9	28.0	40.1	63.4	44.6
1.45	61.8	55.0	29.7	57.5	28.0	41.6	63.3	45.3
1.50	60.8	53.7	28.4	56.6	28.0	41.2	62.9	44.7
1.55	61.8	54.8	29.3	57.2	28.0	40.5	62.9	45.5
1.60	60.3	53.9	29.0	57.0	27.9	40.2	61.9	44.3
1.81	59.7	52.7	28.2	56.6	28.0	37.2	61.1	42.4
4TH PWR AVG	60.6	53.8	27.0	55.3	28.0	39.3	60.7	45.7

SECRET

VEHICLE 1174 TEMPERATURE DATA-ORBIT 39

ASCENDING NODE-ZERO PL TIME= 29405.2 SYSTEM TIME

PL TIME IN HRS.	2I-11	2I-9	+28C1	2I-10	+28C2	-28C1	2I-12	2BAT
0.30	47.5	53.3	28.5	58.4	28.6	4.1	60.5	61.0
0.35	49.3	53.4	28.5	57.9	28.6	4.1	60.8	61.8
0.40	49.3	53.4	28.6	58.0	28.6	4.1	60.4	61.2
0.45	48.7	52.9	28.4	57.5	28.6	4.1	60.0	61.2
0.50	48.9	53.0	28.6	57.5	28.6	4.1	58.9	61.2
0.55	48.4	52.2	28.5	56.7	28.7	4.1	56.4	60.8
0.60	47.7	51.6	28.8	57.2	28.3	4.1	56.7	60.4
0.65	48.8	52.1	28.5	57.2	28.6	4.1	57.2	60.9
0.70	48.6	52.5	28.6	59.3	28.8	4.1	58.0	61.7
0.75	48.1	52.3	28.6	59.5	28.7	4.1	58.6	61.4
0.80	48.2	52.0	28.6	60.5	28.7	4.1	58.4	61.4
0.85	47.6	52.3	28.7	60.6	28.5	4.1	59.2	61.6
0.90	47.9	53.0	28.5	60.7	28.6	4.1	59.9	61.6
0.95	48.3	53.2	28.6	61.6	28.8	4.2	61.3	62.3
1.00	48.6	52.9	28.5	61.2	28.4	4.1	62.4	61.1
1.05	49.0	53.7	28.4	60.7	28.7	4.1	62.5	62.0
1.10	49.3	54.7	28.6	62.0	28.7	4.1	64.7	61.8
1.15	50.0	54.5	28.4	61.7	28.7	4.1	65.6	62.3
1.20	50.3	55.1	28.7	61.7	28.8	4.1	65.6	62.1
1.25	50.5	55.8	28.5	61.1	28.5	4.1	66.4	62.1
1.30	50.9	55.5	28.7	61.3	28.6	4.1	67.2	62.1
1.35	50.1	55.7	28.7	61.2	28.6	4.1	67.1	61.1
1.40	50.4	55.7	28.6	60.7	28.7	4.1	67.4	61.8
1.45	55.0	56.1	28.5	60.0	28.7	4.1	66.6	61.8
1.50	56.5	55.4	28.7	59.7	28.7	4.1	65.6	62.0
1.55	57.2	56.2	28.5	59.9	28.5	4.1	65.4	62.7
1.60	57.3	55.3	28.4	58.9	28.8	4.1	63.1	61.4
1.81	47.5	53.3	28.5	58.4	28.6	4.1	60.5	61.0
4TH PWR AVG	49.8	53.8	28.6	59.5	28.6	4.1	61.9	61.6

VEHICLE 1174 TEMPERATURE DATA-ORBIT 39

ASCENDING NODE=ZERO PL TIME= 29405.2 SYSTEM TIME

PL TIME 2I-13
IN HRS.

0.30	56.2
0.35	57.0
0.40	57.7
0.45	57.8
0.50	57.2
0.55	56.0
0.60	56.7
0.65	57.2
0.70	57.0
0.75	56.4
0.80	56.4
0.85	56.4
0.90	56.3
0.95	56.8
1.00	56.1
1.05	56.8
1.10	56.7
1.15	56.8
1.20	56.4
1.25	56.7
1.30	56.4
1.35	56.8
1.40	56.6
1.45	57.4
1.50	57.0
1.55	57.8
1.60	57.6
1.81	56.2

4TH PWR AVG 56.8

~~SECRET~~
~~SECRET~~

VEHICLE 1174 TEMPERATURE DATA-ORBIT 72

ASCENDING NODE=ZERO PL TIME= 36474.4 SYSTEM TIME

PL TIME IN HRS.	1B-2	HALF	1B-1	11-3	1B-4	11-4	1B-3	11-5
0.25	-2.2	2.5	4.9	38.1	30.1	41.4	19.5	48.4
0.30	-5.2	2.5	0.1	37.2	25.3	40.5	13.7	48.6
0.35	-4.7	2.5	0.2	37.8	24.6	40.6	8.6	49.5
0.40	-6.0	2.5	-1.3	37.6	26.5	40.6	5.7	48.0
0.45	-8.4	2.5	-4.7	36.4	30.5	38.7	8.9	47.8
0.50	-11.0	2.5	-0.6	36.2	39.0	38.5	12.4	46.3
0.55	-7.0	2.5	8.9	36.2	51.2	39.2	27.0	46.8
0.60	-3.2	2.5	12.9	36.5	65.5	39.5	41.7	46.4
0.65	2.8	2.5	16.1	36.3	78.7	39.8	62.7	47.4
0.70	8.1	2.5	19.1	35.6	89.3	39.1	82.5	46.8
0.75	15.1	2.5	22.3	35.2	100.8	39.4	101.1	46.0
0.80	20.7	2.5	22.8	35.0	110.3	39.1	115.8	46.5
0.85	27.8	2.5	23.0	35.2	119.2	39.5	129.1	46.6
0.90	32.7	2.5	26.5	36.2	128.9	40.2	136.5	47.5
0.95	35.0	2.5	27.5	36.4	131.3	40.8	141.1	46.7
1.00	33.2	2.5	29.0	35.7	131.9	41.0	141.5	47.4
1.05	35.7	2.5	30.5	36.2	132.7	41.7	132.5	47.9
1.10	31.3	2.5	27.6	36.3	130.0	41.4	126.6	48.4
1.15	30.0	2.5	24.1	37.2	126.9	43.7	108.0	50.0
1.20	28.2	2.5	21.3	37.9	117.2	42.9	93.9	49.5
1.25	25.0	2.5	17.5	38.0	107.0	43.0	83.0	49.5
1.30	21.4	2.5	14.2	38.2	94.1	43.4	72.9	50.0
1.35	19.0	2.5	15.4	38.6	86.2	43.8	63.1	50.4
1.40	19.5	2.5	13.7	39.0	75.4	43.6	56.1	51.0
1.45	14.1	2.5	12.3	38.4	67.4	44.0	51.0	50.6
1.50	11.6	2.5	10.0	39.1	59.9	43.7	41.1	50.6
1.76	-2.2	2.5	4.9	38.1	30.1	41.4	19.5	48.4

4TH PWR AVG 12.0 2.5 13.5 37.0 80.0 41.1 70.3 48.3



~~SECRET~~

SECRET
SECRET
VEHICLE 1174 TEMPERATURE DATA-ORBIT 72

ASCENDING NODE=ZERO PL TIME= 36474.4 SYSTEM TIME

PL TIME IN HRS.	18-5	11-7	28-2	11-8	28-1	11-9	11-11	11-10
0.25	34.9	53.5	34.7	51.0	43.6	58.9	45.6	52.8
0.30	30.6	53.7	30.7	49.8	41.1	57.6	44.6	51.7
0.35	34.5	53.2	30.0	50.4	41.6	58.0	45.5	52.8
0.40	38.7	52.2	34.1	49.7	45.6	56.9	44.3	51.5
0.45	42.5	53.5	38.8	48.6	53.0	55.9	43.1	50.8
0.50	43.3	50.7	45.7	46.9	50.2	53.8	43.1	50.9
0.55	48.2	52.6	57.8	48.9	54.3	54.7	44.6	50.9
0.60	52.2	51.0	67.9	48.7	55.8	54.3	45.1	52.4
0.65	54.6	52.1	80.8	48.2	57.4	54.9	49.5	53.5
0.70	54.6	52.7	89.9	47.8	60.5	54.5	50.6	53.4
0.75	54.9	53.3	99.9	47.7	59.7	55.5	53.0	54.8
0.80	58.5	53.2	108.5	47.3	63.4	55.3	53.2	54.7
0.85	58.4	53.3	117.9	47.6	62.6	56.4	55.0	54.8
0.90	62.2	53.3	126.4	49.0	62.3	58.5	57.1	56.2
0.95	64.1	53.6	127.5	48.2	68.0	58.8	57.5	56.1
1.00	66.2	54.5	126.3	48.7	67.7	58.8	57.5	55.7
1.05	70.8	54.2	127.7	49.8	72.4	60.9	59.6	57.1
1.10	73.9	55.7	123.7	50.7	78.6	61.1	60.0	57.7
1.15	78.7	55.4	120.7	51.8	79.7	63.1	60.9	57.8
1.20	82.5	55.7	111.2	52.2	84.5	62.5	60.7	57.0
1.25	87.0	54.5	101.6	52.2	86.6	62.4	59.7	56.4
1.30	75.1	54.6	92.8	52.5	77.7	62.9	60.8	56.9
1.35	70.6	54.8	84.1	52.8	72.5	62.6	57.6	56.9
1.40	63.8	54.4	74.9	53.3	66.4	62.1	53.2	55.8
1.45	58.4	55.8	67.8	53.1	64.2	61.6	51.8	55.3
1.50	53.7	54.7	60.7	52.7	60.0	61.2	50.1	54.7
1.76	34.9	53.5	34.7	51.0	43.6	58.9	45.6	52.8
4TH PWR AVG	55.1	53.7	79.9	50.0	60.1	58.5	51.4	54.2

SECRET

VEHICLE 1174 TEMPERATURE DATA-ORBIT 72

ASCENDING NODE=ZERO PL TIME= 36474.4 SYSTEM TIME

PL TIME IN HRS.	SC-1	28-3	11-13	28-4	11-12	28-5	21-4	A1-1
0.25	47.2	18.0	51.3	2.3	47.0	7.4	57.4	53.6
0.30	46.3	16.5	51.0	-0.1	45.8	3.0	56.6	50.7
0.35	47.4	14.2	51.9	-0.6	44.9	2.1	55.6	49.1
0.40	46.2	10.9	51.2	-2.8	44.5	-1.9	54.4	46.4
0.45	45.8	10.1	50.4	-4.7	44.8	2.6	54.7	46.7
0.50	45.6	16.6	50.3	-6.9	42.4	2.5	53.0	44.7
0.55	45.9	30.0	51.2	-1.9	43.4	9.8	53.2	47.3
0.60	45.9	45.7	51.3	-0.4	42.1	12.1	52.9	45.2
0.65	46.3	64.2	52.2	5.8	42.9	16.4	53.2	49.3
0.70	45.3	78.5	51.3	9.6	43.0	20.4	53.7	52.6
0.75	45.2	96.2	51.7	14.1	43.9	23.7	53.8	55.2
0.80	44.5	107.6	51.8	20.7	44.1	22.3	54.4	58.9
0.85	45.3	118.6	51.8	25.2	44.3	21.9	54.4	61.9
0.90	46.2	129.0	53.1	30.2	44.7	24.4	54.7	65.2
0.95	45.7	130.8	52.5	31.0	46.5	28.6	55.8	72.4
1.00	45.0	127.5	52.5	29.8	47.2	28.8	56.8	76.9
1.05	46.3	123.2	53.3	30.0	46.8	27.5	56.7	82.2
1.10	45.3	111.9	53.3	29.5	49.0	28.0	58.4	89.2
1.15	47.3	100.7	53.4	28.1	48.4	24.4	58.7	91.7
1.20	47.4	85.5	53.8	24.0	48.9	19.2	59.2	95.1
1.25	47.5	76.0	54.3	22.4	49.2	17.0	59.4	95.2
1.30	48.1	67.8	53.9	21.0	49.1	14.9	59.6	89.6
1.35	47.5	60.9	54.0	18.8	48.9	14.0	60.2	83.4
1.40	48.1	54.0	53.5	15.9	49.6	12.5	59.8	77.3
1.45	48.1	47.0	53.6	14.2	49.7	10.4	59.5	74.1
1.50	47.7	40.8	53.2	11.0	48.5	9.8	59.3	69.9
1.76	47.2	18.0	51.3	2.3	47.0	7.4	57.4	53.6
4TH PWR AVG	46.4	66.0	52.2	12.6	46.1	14.2	56.4	64.8

~~SECRET~~

VEHICLE 1174 TEMPERATURE DATA-ORBIT 72

ASCENDING NODE=ZERO PL TIME= 36474.4 SYSTEM TIME

PL TIME IN HRS.	21-3	CL-1	2TC-1	CL-2	+288U	21-5	21-7	21-6
0.25	53.7	65.0	36.8	58.5	28.2	52.5	54.0	47.5
0.30	54.0	63.7	36.6	58.3	28.2	51.8	53.7	46.9
0.35	52.9	64.0	35.8	57.4	28.2	51.5	54.4	47.1
0.40	51.4	62.2	35.3	56.5	28.1	50.2	54.0	47.2
0.45	52.4	63.0	35.8	56.2	28.2	50.9	53.1	46.1
0.50	50.7	61.0	34.6	53.6	28.1	49.4	51.8	45.9
0.55	51.5	61.7	35.1	55.1	28.2	50.0	52.2	48.1
0.60	50.7	61.4	34.2	54.4	28.1	49.1	52.7	47.4
0.65	51.7	61.9	34.7	55.9	28.2	49.6	53.2	48.8
0.70	52.1	62.9	34.1	56.7	28.2	49.6	53.9	47.3
0.75	52.0	62.5	34.5	58.2	28.2	49.6	54.3	47.1
0.80	52.0	63.4	34.5	57.6	28.2	49.4	55.2	46.5
0.85	52.3	64.3	34.6	58.2	28.2	49.7	55.0	46.7
0.90	52.1	63.9	34.9	58.1	28.2	49.8	55.5	47.6
0.95	53.4	64.4	35.5	58.9	28.2	50.4	55.8	47.1
1.00	53.3	66.7	36.1	61.0	28.2	51.5	55.4	46.8
1.05	53.5	65.4	36.1	59.9	28.2	51.5	56.6	47.1
1.10	54.7	67.9	37.2	62.4	28.3	52.8	56.5	46.8
1.15	55.0	67.1	36.4	61.1	28.2	52.7	56.8	48.4
1.20	55.0	68.4	37.0	62.0	28.2	53.2	56.3	48.2
1.25	55.4	67.4	37.1	62.8	28.2	53.0	56.2	48.2
1.30	55.0	68.8	36.9	63.5	28.2	53.0	56.8	47.7
1.35	56.0	69.0	37.2	62.1	28.2	53.3	56.9	49.1
1.40	55.8	68.9	37.8	62.4	28.2	53.4	56.7	48.6
1.45	56.2	69.7	38.5	64.1	28.2	54.1	56.5	49.0
1.50	55.9	68.3	37.7	62.1	28.2	53.8	56.0	48.3
1.76	53.7	65.0	36.8	58.5	28.2	52.5	54.0	47.5
4TH PWR AVG	53.4	65.0	36.1	59.0	28.2	51.5	54.8	47.5

~~SECRET~~

~~SECRET~~

VEHICLE 1174 TEMPERATURE DATA-ORBIT 72

ASCENDING NODE=ZERO PL TIME= 36474.4 SYSTEM TIME

PL TIME IN HRS.	2TC-2	SC-2	-28BU	2S1-2	21-8	21-9	+28C1	21-10
0.25	43.2	50.2	28.0	47.2	55.7	49.1	28.6	52.3
0.30	41.7	48.9	28.0	44.8	55.1	48.8	28.4	51.8
0.35	42.7	49.2	27.9	43.9	55.4	49.0	28.9	52.2
0.40	42.0	48.2	28.0	42.7	54.5	49.0	28.6	51.0
0.45	41.7	48.4	28.0	45.6	53.2	47.7	28.6	50.5
0.50	40.6	46.5	28.0	41.8	51.9	47.0	28.5	49.8
0.55	41.3	47.6	28.0	44.9	53.0	47.5	28.6	51.4
0.60	41.6	46.7	27.9	43.2	53.8	47.9	28.8	52.1
0.65	42.1	46.8	27.9	46.5	53.2	47.5	28.8	53.5
0.70	41.5	46.3	28.0	46.3	53.3	47.2	28.7	53.5
0.75	41.6	46.9	28.0	48.1	52.6	46.7	28.8	55.2
0.80	41.3	46.7	28.0	45.1	52.2	47.3	28.5	54.6
0.85	41.5	46.6	28.0	46.9	52.6	47.6	28.5	55.1
0.90	42.5	46.8	27.9	46.3	53.6	49.1	28.9	56.7
0.95	42.5	47.8	28.0	49.3	53.4	48.3	28.6	56.1
1.00	42.3	48.9	28.0	49.3	53.8	48.6	28.6	56.9
1.05	43.1	48.6	27.9	50.0	54.4	49.6	28.7	57.6
1.10	43.0	50.7	28.0	54.2	54.9	50.0	28.5	57.7
1.15	44.0	50.0	28.0	49.1	55.6	51.2	28.7	58.4
1.20	44.0	50.6	28.0	49.5	57.1	51.0	28.7	57.3
1.25	44.1	50.3	28.0	48.7	57.0	51.4	28.6	57.0
1.30	44.3	51.1	28.0	49.4	56.1	51.1	28.6	56.6
1.35	44.3	51.5	28.0	48.2	57.2	51.8	28.7	55.9
1.40	43.5	51.7	28.0	48.5	57.9	51.9	28.6	56.2
1.45	44.7	52.5	28.0	50.8	57.7	51.7	28.6	55.1
1.50	44.2	51.7	28.0	48.2	57.4	50.9	28.4	54.8
1.76	43.2	50.2	28.0	47.2	55.7	49.1	28.6	52.3
4TH PWR AVG	42.6	48.9	28.0	47.0	54.8	49.1	28.6	54.2



SECRET

VEHICLE 1174 TEMPERATURE DATA-ORBIT 72

ASCENDING NODE=ZERO PL TIME= 36474.4 SYSTEM TIME

PL TIME IN HRS.	+28C2	-28C1	21-12	28AT	21-13	-28C2
0.25	29.0	4.1	55.0	103.2	52.7	4.1
0.30	28.8	4.1	53.9	102.5	51.7	4.0
0.35	28.7	4.2	54.0	104.7	53.2	4.1
0.40	28.5	4.1	52.4	103.7	52.4	4.1
0.45	28.6	4.1	51.0	103.4	51.7	4.1
0.50	28.4	4.1	50.1	101.7	51.6	4.1
0.55	28.7	4.1	51.4	103.1	51.8	4.1
0.60	28.6	4.2	51.2	103.7	51.5	4.1
0.65	28.7	4.2	51.7	104.4	52.3	4.1
0.70	28.6	4.1	51.1	103.3	51.1	4.1
0.75	28.5	4.1	51.3	104.6	51.2	4.1
0.80	28.7	4.1	52.3	103.4	50.5	4.0
0.85	28.6	4.1	52.6	103.7	50.8	4.1
0.90	28.6	4.2	55.5	106.3	52.1	4.2
0.95	28.7	4.1	54.8	104.7	51.3	4.1
1.00	28.8	4.1	56.0	105.0	51.0	4.1
1.05	28.7	4.1	57.2	105.6	51.3	4.1
1.10	28.9	4.1	58.1	106.4	51.8	4.1
1.15	28.6	4.2	59.6	106.9	52.2	4.1
1.20	28.7	4.1	59.4	106.2	52.1	4.1
1.25	28.5	4.1	60.3	106.4	52.0	4.1
1.30	28.5	4.1	60.4	106.4	52.1	4.1
1.35	28.6	4.1	59.7	106.5	52.6	4.1
1.40	28.6	4.1	59.6	105.6	52.3	4.1
1.45	28.9	4.1	59.5	107.0	52.7	4.1
1.50	28.7	4.1	58.4	106.3	52.7	4.1
1.76	29.0	4.1	55.0	103.2	52.7	4.1
4TH PWR AVG	28.7	4.1	55.1	104.5	51.9	4.1



~~SECRET~~
~~SECRET~~

VEHICLE 1174 TEMPERATURE DATA-ORBIT 85

ASCENDING NODE=ZERO PL TIME= 20902.0 SYSTEM TIME

PL TIME- IN HRS.	18-2	HALF	18-1	11-3	18-4	11-4	18-3	11-5
0.05	3.7	2.5	3.9	33.8	46.2	36.5	31.0	44.0
0.10	1.7	2.5	5.0	34.7	39.7	38.4	25.9	45.7
0.15	1.0	2.4	4.5	34.7	34.8	38.8	18.9	45.2
0.20	-1.2	2.5	0.1	34.6	29.2	38.2	16.2	45.6
0.25	-3.2	2.5	0.8	34.2	24.9	38.2	12.5	45.6
0.30	-5.7	2.5	-1.6	33.9	20.4	37.7	9.1	45.2
0.35	-7.9	2.5	-3.8	34.1	20.4	37.2	3.5	44.4
0.40	-10.2	2.5	-5.0	33.9	19.9	36.5	2.3	44.5
0.45	-11.4	2.5	-4.5	33.7	29.0	36.1	5.8	43.7
0.50	-9.5	2.5	-2.1	32.1	35.7	36.0	15.4	43.4
0.55	-9.5	2.5	4.6	31.7	50.5	36.0	31.2	41.7
0.60	-1.4	2.5	13.5	31.5	63.2	36.7	54.5	42.9
0.65	5.9	2.5	14.3	31.6	77.6	35.7	73.0	41.8
0.70	16.9	2.5	17.8	31.5	89.2	36.1	92.8	42.8
0.75	22.6	2.5	21.8	31.8	98.7	36.2	111.8	42.2
0.80	29.5	2.5	23.2	31.2	110.8	37.3	126.3	42.4
0.85	35.1	2.5	23.4	32.0	116.8	36.9	135.3	42.3
0.90	38.3	2.5	26.3	32.9	123.5	37.3	141.0	43.3
0.95	40.4	2.5	28.0	32.6	125.1	37.5	138.2	43.3
1.00	36.6	2.4	17.3	34.3	123.2	36.5	131.4	42.4
1.05	35.0	2.4	24.8	33.8	104.0	38.4	118.4	44.0
1.10	20.1	2.5	-41.6	33.0	114.9	39.8	104.0	44.2
1.15	20.1	2.5	18.7	35.1	114.9	39.8	90.9	42.1
1.56	3.7	2.5	3.9	33.8	46.2	36.5	31.0	44.0

4TH PWR AVG 8.7 2.5 7.5 33.4 63.5 37.2 61.6 44.0

SECRET

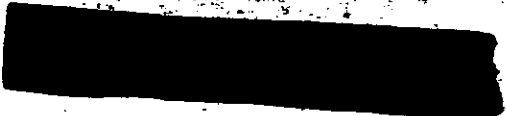

VEHICLE 1174 TEMPERATURE DATA-ORBIT 85

ASCENDING NODE=ZERO PL TIME= 20902.0 SYSTEM TIME

PL TIME IN HRS.	18-5	11-7	28-2	11-8	28-1	11-9	11-11	11-10
0.05	40.8	49.4	48.2	46.9	45.9	56.5	51.5	49.9
0.10	41.2	50.2	42.8	47.6	44.7	56.7	53.0	50.5
0.15	35.7	49.4	38.7	48.1	42.7	56.8	52.7	50.6
0.20	31.7	50.0	34.4	47.6	40.4	56.4	51.6	49.7
0.25	27.7	49.9	31.0	47.6	36.5	56.2	51.9	49.5
0.30	25.4	50.2	24.6	47.1	33.1	55.7	51.3	49.7
0.35	31.3	49.8	24.3	46.7	38.3	54.8	50.5	49.1
0.40	35.3	48.8	28.7	46.1	43.5	54.1	49.8	48.6
0.45	36.9	48.3	35.2	45.2	44.8	53.5	49.9	48.0
0.50	39.0	48.0	42.8	44.7	44.2	50.2	46.1	47.3
0.55	38.8	48.2	53.5	44.3	46.6	49.7	44.9	47.9
0.60	44.1	48.7	68.0	44.3	51.7	50.7	47.2	48.9
0.65	41.5	48.7	79.2	43.8	48.3	51.2	48.2	50.3
0.70	46.6	48.9	89.7	44.7	50.3	51.4	48.6	50.6
0.75	49.1	49.2	102.1	43.9	54.6	52.5	50.2	51.3
0.80	51.9	49.8	107.4	44.0	55.7	53.1	50.6	52.2
0.85	54.8	49.9	114.0	44.0	57.8	54.1	50.9	52.2
0.90	58.2	50.4	119.9	44.5	59.8	55.6	52.4	52.2
0.95	61.0	50.1	122.2	46.0	63.1	56.1	53.4	52.1
1.00	58.3	49.8	117.4	45.9	60.0	57.2	54.5	53.8
1.05	67.0	50.5	114.7	38.6	67.3	57.2	55.7	53.5
1.10	69.3	48.9	102.6	46.6	56.9	58.8	54.2	53.4
1.15	75.3	50.8	102.6	46.6	75.7	58.3	54.8	52.6
1.56	40.8	49.4	48.2	46.9	45.9	56.5	51.5	49.9
4TH PWR AVG	44.7	49.5	65.4	45.9	49.0	55.1	51.3	50.5



SECRET

~~SECRET~~
~~SECRET~~

VEHICLE 1174 TEMPERATURE DATA-ORBIT 85

ASCENDING NODE=ZERO PL TIME= 20902.0 SYSTEM TIME

PL TIME IN HRS.	SC-1	28-3	11-13	28-4	11-12	28-5	21-4	AI-1
0.05	45.4	32.5	49.8	5.4	42.6	3.1	52.9	56.8
0.10	45.8	28.6	52.0	3.9	43.3	5.0	53.5	55.7
0.15	45.3	24.5	51.3	2.7	44.0	3.4	53.3	52.0
0.20	45.3	20.8	51.3	0.9	44.0	1.0	53.7	48.2
0.25	45.2	15.1	51.7	-1.1	43.4	-0.6	53.6	47.5
0.30	44.4	11.5	51.5	-2.2	42.7	-2.3	53.1	45.6
0.35	45.0	9.4	51.1	-4.1	41.5	-3.2	52.0	42.3
0.40	43.8	8.0	50.8	-7.2	41.5	-4.3	51.2	41.4
0.45	44.2	8.9	50.2	-7.6	40.7	-2.6	50.2	40.0
0.50	42.7	18.4	48.8	-8.8	40.7	-1.2	49.0	40.5
0.55	43.1	34.7	48.0	-3.9	38.6	4.4	49.6	38.4
0.60	43.3	51.3	48.7	1.0	40.5	12.5	50.4	42.9
0.65	43.3	70.0	49.1	5.8	39.3	14.1	49.8	41.3
0.70	42.5	87.9	48.7	15.4	40.0	16.8	50.0	46.0
0.75	42.4	105.3	49.2	21.3	41.2	20.5	51.2	51.2
0.80	42.8	118.8	48.5	27.0	41.7	24.7	50.0	54.1
0.85	42.7	125.4	49.2	30.0	42.1	22.3	51.0	58.1
0.90	42.6	129.7	49.3	31.7	42.3	24.9	51.3	64.2
0.95	43.2	127.5	49.7	33.7	43.3	24.9	52.1	68.8
1.00	40.5	121.1	49.6	14.6	43.5	21.0	53.6	70.6
1.05	42.2	108.3	47.1	32.1	45.3	22.0	52.9	76.7
1.10	43.6	94.1	50.6	28.6	44.8	20.0	48.4	82.6
1.15	44.4	94.1	50.6	28.6	46.6	20.0	55.4	86.5
1.56	45.4	32.5	49.8	5.4	42.6	3.1	52.9	56.8

4TH PWR AVG 44.1 57.1 50.1 8.6 42.5 8.6 52.0 54.7

~~SECRET~~

~~SECRET~~
~~UNCLASSIFIED~~

VEHICLE 1174 TEMPERATURE DATA-ORBIT 85

ASCENDING NODE=ZERO PL TIME= 20902.0 SYSTEM TIME

PL TIME IN HRS.	21-3	CL-1	2TC-1	CL-2	+288U	21-5	21-7	21-6
0.05	48.8	63.5	35.1	56.3	28.2	46.4	50.1	42.5
0.10	49.9	61.8	35.5	56.7	28.2	48.1	50.7	43.5
0.15	50.1	60.8	35.2	56.5	28.2	47.9	51.6	44.6
0.20	49.3	60.0	35.4	55.1	28.2	48.7	50.2	43.8
0.25	49.0	60.9	35.5	54.4	28.2	47.9	51.0	43.3
0.30	48.4	59.5	35.2	53.9	28.2	47.8	50.3	43.3
0.35	48.2	59.7	34.9	54.7	28.2	47.6	50.2	43.5
0.40	47.5	58.9	33.6	52.7	28.2	47.3	49.7	42.0
0.45	46.8	58.3	33.7	51.7	28.2	46.3	49.0	42.6
0.50	46.7	87.4	33.3	52.5	28.1	45.1	71.2	43.1
0.55	45.7	58.9	32.2	51.0	28.1	45.5	49.4	44.0
0.60	47.1	58.4	32.6	53.0	28.2	44.8	49.4	44.6
0.65	46.9	58.5	32.0	52.1	28.2	45.4	50.0	43.9
0.70	47.1	58.8	32.7	53.4	28.2	46.0	49.8	43.2
0.75	46.9	59.2	32.5	54.3	28.2	45.0	50.9	42.5
0.80	46.9	59.5	32.5	56.4	28.2	44.8	50.4	42.7
0.85	48.0	59.5	32.5	55.2	28.2	45.7	50.2	42.2
0.90	47.8	60.0	33.2	55.4	28.2	45.9	51.4	42.7
0.95	48.0	61.8	33.9	55.9	28.2	46.7	52.3	42.7
1.00	49.2	58.8	27.1	57.1	28.2	46.2	49.1	35.9
1.05	48.1	63.7	34.4	61.0	28.2	39.9	52.4	42.7
1.10	43.2	57.7	34.5	14.1	27.6	48.4	33.1	43.0
1.15	49.9	57.7	34.5	14.1	28.2	48.4	52.8	43.0
1.56	48.8	63.5	35.1	56.3	28.2	46.4	50.1	42.5

4TH PWR AVG 48.2 61.7 34.0 54.6 28.2 46.5 50.6 42.9



~~SECRET~~
~~UNCLASSIFIED~~

VEHICLE 1174 TEMPERATURE DATA-ORBIT 85

ASCENDING NODE=ZERO PL TIME= 20902.0 SYSTEM TIME

PL TIME IN HRS.	2TC-2	SC-2	-28BU	2SI-2	2I-8	2I-9	+28C1	2I-10
0.05	39.9	48.1	28.0	42.3	51.8	44.4	28.6	48.5
0.10	41.2	48.7	28.0	42.2	52.4	45.1	28.4	49.0
0.15	40.6	47.2	28.0	40.9	52.9	44.8	28.7	50.1
0.20	40.4	47.2	28.0	41.8	52.9	45.5	28.5	49.6
0.25	40.0	47.7	28.0	43.0	52.6	45.8	28.6	49.2
0.30	39.6	47.2	28.0	41.2	52.0	45.3	28.6	48.8
0.35	40.1	45.7	28.0	40.0	51.6	45.0	28.6	47.7
0.40	39.5	46.0	28.0	40.0	51.2	44.9	28.6	47.2
0.45	39.6	44.9	27.9	41.3	50.3	43.6	28.5	47.6
0.50	38.7	44.8	28.0	39.9	50.0	43.6	28.4	46.7
0.55	38.8	43.1	27.9	39.7	49.0	41.9	28.4	47.4
0.60	38.9	43.5	28.0	41.2	50.8	42.6	28.7	48.0
0.65	38.2	43.0	28.0	42.8	49.4	42.2	28.6	49.0
0.70	38.9	44.0	28.0	42.4	49.3	42.9	28.5	50.1
0.75	38.9	43.1	28.0	42.8	49.0	43.0	28.7	50.7
0.80	39.5	43.3	27.9	43.9	49.1	42.7	28.6	51.3
0.85	38.9	43.9	28.0	45.5	50.0	43.7	28.6	51.9
0.90	39.0	44.9	28.0	43.4	50.2	44.7	28.7	52.5
0.95	39.6	44.5	28.0	47.5	50.3	44.8	28.7	53.5
1.00	37.2	43.5	28.1	45.1	50.6	43.3	28.5	51.7
1.05	41.0	45.1	28.1	9.0	52.0	45.7	28.7	53.9
1.10	40.9	45.5	28.0	47.4	51.0	47.5	28.6	52.5
1.15	40.9	45.5	28.0	47.4	53.0	47.5	28.6	52.4
1.56	39.9	48.1	28.0	42.3	51.8	44.4	28.6	48.5

4TH PWR AVG 39.8 46.2 28.0 41.3 51.2 44.3 28.6 49.6

SECRET



VEHICLE 1174 TEMPERATURE DATA-ORBIT 85

ASCENDING NCDE=ZERO PL TIME= 20902.0 SYSTEM TIME

PL TIME IN HRS.	+28C2	-28C1	21-12	28AT	21-13	-28C2
0.05	28.6	4.1	52.1	101.4	46.9	4.0
0.10	28.5	4.1	52.3	102.9	48.2	4.1
0.15	28.5	4.1	52.4	102.4	48.5	4.0
0.20	28.7	4.1	51.8	102.4	49.4	4.1
0.25	28.6	4.1	51.1	102.2	48.9	4.1
0.30	28.6	4.1	50.0	103.1	48.8	4.1
0.35	28.7	4.1	48.9	103.1	48.6	4.1
0.40	28.6	4.1	48.7	103.3	48.8	4.1
0.45	28.7	4.1	47.2	103.8	48.3	4.1
0.50	28.5	4.1	47.1	101.7	47.5	4.1
0.55	28.4	4.1	47.2	102.1	46.3	4.1
0.60	28.6	4.1	47.7	103.7	47.3	4.1
0.65	28.5	4.1	48.0	104.0	47.1	4.1
0.70	28.5	4.1	47.8	104.1	47.3	4.1
0.75	28.5	4.1	48.1	104.5	47.2	4.1
0.80	28.5	4.1	49.0	104.8	47.6	4.0
0.85	28.6	4.1	49.9	105.3	47.4	4.1
0.90	28.5	4.1	50.6	106.5	47.9	4.0
0.95	28.6	4.1	52.6	105.6	47.2	4.1
1.00	29.0	4.1	50.6	106.4	48.2	4.0
1.05	28.7	4.1	54.2	104.5	47.2	4.0
1.10	28.7	4.1	54.9	106.9	47.7	4.1
1.15	30.1	4.1	50.6	106.9	47.7	3.9
1.56	28.6	4.1	52.1	101.4	46.9	4.0

4TH PWR AVG 28.6 4.1 50.7 103.5 47.8 4.1



~~SECRET~~
~~SECRET~~

VEHICLE 1174 TEMPERATURE DATA-ORBIT 101

ASCENDING NODE=ZERO PL TIME= 21660.0 SYSTEM TIME

PL TIME IN HRS.	11-3	18-4	11-4	18-3	11-5	18-5	11-7	28-2
0.05	33.7	41.3	36.6	31.5	43.5	37.9	47.6	41.7
0.10	34.6	35.0	37.8	23.5	45.0	33.8	48.3	38.7
0.15	33.6	31.8	37.0	21.6	43.7	31.3	49.3	32.5
0.20	35.1	26.0	38.7	15.1	44.7	28.9	48.7	30.8
0.25	33.4	22.5	36.8	14.2	44.2	25.7	49.2	27.0
0.30	34.3	19.8	37.1	9.6	44.3	21.8	49.0	23.7
0.35	33.9	16.9	37.1	5.8	43.4	20.2	47.9	20.1
0.40	33.7	13.9	36.1	2.4	42.8	26.5	47.9	19.8
0.45	32.9	19.7	35.7	2.6	42.6	28.1	47.6	23.2
0.50	32.9	23.3	34.9	6.6	42.0	29.0	46.8	28.1
0.55	31.4	32.6	33.9	17.8	41.6	33.2	46.5	37.9
0.60	31.8	44.9	34.0	34.8	41.9	35.7	46.9	47.3
0.65	31.6	54.1	34.3	51.8	41.4	39.1	46.7	58.8
0.70	31.1	67.7	34.3	71.4	41.4	37.7	47.1	69.4
0.75	23.5	77.8	31.0	78.9	29.8	40.3	46.6	79.4
0.80	30.8	90.6	34.4	107.7	41.7	42.4	47.2	90.6
0.85	30.1	100.6	34.5	122.6	41.2	46.2	46.4	97.7
0.90	30.5	107.2	34.8	133.3	41.8	45.9	47.1	104.8
0.95	30.7	110.3	34.7	138.5	41.0	46.1	47.6	109.1
1.00	31.8	116.2	35.6	141.1	42.1	52.0	48.0	111.9
1.05	31.6	117.4	36.9	138.0	42.5	55.5	47.7	111.8
1.10	31.9	113.9	37.1	129.4	43.0	55.3	47.9	110.6
1.15	33.4	110.1	37.0	113.9	42.9	57.3	48.0	106.1
1.20	33.4	104.5	37.7	99.9	43.2	58.9	48.3	98.7
1.25	33.9	92.4	38.7	88.3	43.7	61.4	48.5	90.0
1.30	33.7	86.0	38.1	75.7	44.3	63.0	48.3	80.5
1.35	33.5	74.7	38.8	65.3	44.2	56.0	48.4	73.8
1.40	34.5	67.7	39.2	58.3	44.5	51.9	48.3	66.7
1.56	33.7	41.3	36.6	31.5	43.5	37.9	47.6	41.7
4TH PWR AVG	32.6	66.1	36.2	67.6	42.6	41.2	47.8	66.1

~~SECRET~~

~~SECRET~~



VEHICLE 1174 TEMPERATURE DATA-ORBIT 101

ASCENDING NODE=ZERO PL TIME= 21660.0 SYSTEM TIME

PL TIME IN HRS.	11-8	2B-1	11-9	11-11	11-10	SC-1	2B-3	11-13
0.05	45.6	43.4	54.9	48.0	48.5	44.1	30.2	48.4
0.10	45.5	40.3	55.4	49.5	48.6	43.7	24.8	49.1
0.15	46.6	37.4	55.3	50.0	48.8	44.1	22.7	50.4
0.20	45.9	36.2	54.6	50.0	48.9	43.5	16.3	50.3
0.25	45.9	34.3	54.3	49.1	48.3	43.5	16.7	50.8
0.30	46.0	31.7	54.2	49.3	47.7	43.7	11.6	50.1
0.35	45.9	31.7	53.2	48.4	47.9	43.6	9.7	50.7
0.40	44.5	34.7	52.2	47.5	47.2	42.5	6.8	49.7
0.45	44.2	35.7	52.0	47.4	46.3	42.7	6.8	49.4
0.50	43.4	35.8	51.3	47.3	46.2	42.3	10.0	49.1
0.55	43.2	38.1	48.8	45.1	45.8	41.7	20.8	47.6
0.60	43.4	43.0	50.1	46.5	46.7	41.3	33.3	47.9
0.65	43.0	46.3	49.7	47.0	47.7	41.3	51.7	48.4
0.70	41.9	44.6	49.2	47.3	48.0	40.7	68.2	48.7
0.75	36.3	30.0	49.9	45.2	59.6	34.0	77.4	44.2
0.80	42.4	48.6	50.3	49.2	49.0	40.7	101.7	48.2
0.85	48.2	68.6	56.9	49.5	49.9	43.7	115.0	48.5
0.90	42.3	50.1	51.5	50.4	49.8	40.6	123.1	48.1
0.95	42.8	52.6	52.2	51.5	49.8	40.8	128.5	48.5
1.00	43.6	55.3	53.5	52.0	50.8	41.4	130.4	48.0
1.05	43.7	56.8	54.4	53.1	51.2	41.0	126.2	48.6
1.10	44.8	58.6	54.7	53.2	51.5	42.2	117.8	48.5
1.15	45.2	60.0	56.0	54.6	51.7	42.1	106.1	48.8
1.20	46.3	61.8	56.1	53.7	51.4	43.1	91.4	49.0
1.25	46.1	66.4	56.9	54.3	51.5	43.1	79.7	48.7
1.30	46.1	65.4	56.3	54.2	51.3	43.2	71.4	48.8
1.35	46.7	58.8	56.6	54.4	51.2	42.7	61.3	49.1
1.40	47.1	55.4	56.1	53.8	50.8	43.5	56.2	49.1
1.56	45.6	43.4	54.9	48.0	48.5	44.1	30.2	48.4
4TH PWR AVG	44.6	46.9	53.6	49.9	49.4	42.3	63.6	48.8



~~SECRET~~

~~SECRET~~
~~SECRET~~

VEHICLE 1174 TEMPERATURE DATA-ORBIT 101

ASCENDING NODE=ZERO PL TIME= 21660.0 SYSTEM TIME

PL TIME IN HRS.	28-4	11-12	28-5	21-4	AI-1	21-3	CL-1	2TC-1
0.05	7.3	43.0	5.5	50.9	53.6	47.4	63.4	36.1
0.10	5.4	43.8	5.0	51.7	51.6	47.2	62.2	36.2
0.15	4.5	42.3	1.1	51.4	48.2	47.7	61.7	35.3
0.20	2.2	43.3	1.4	51.8	44.8	47.1	61.2	35.5
0.25	-0.3	42.2	-0.6	51.7	44.0	46.8	61.3	35.6
0.30	-0.5	42.5	-1.6	50.8	41.2	46.6	61.3	34.2
0.35	-3.0	41.5	-4.6	50.8	39.0	46.1	60.3	34.0
0.40	-5.8	41.2	-4.5	49.7	38.8	45.6	59.8	33.9
0.45	-6.2	40.0	-5.7	49.2	38.7	45.0	58.2	34.3
0.50	-7.4	39.8	-3.4	48.5	35.2	44.2	58.2	33.5
0.55	-6.0	38.3	0.6	47.4	35.7	44.0	57.7	32.4
0.60	-1.6	39.1	6.9	48.1	38.7	43.9	57.1	32.8
0.65	3.2	39.0	11.0	46.7	37.9	44.0	58.1	32.1
0.70	8.0	38.2	10.5	47.4	40.6	44.2	58.5	32.3
0.75	12.7	38.8	11.9	42.1	34.7	38.3	49.1	37.7
0.80	23.1	39.5	15.5	46.9	45.0	44.2	58.0	32.2
0.85	29.6	43.0	18.5	44.6	47.6	43.9	68.6	32.0
0.90	33.6	40.3	21.0	47.4	48.7	44.4	59.7	32.9
0.95	37.4	41.3	21.5	47.8	52.7	44.3	60.0	32.3
1.00	38.3	42.4	23.0	48.8	59.1	44.7	61.6	32.8
1.05	39.2	42.5	24.2	49.5	64.2	45.3	61.2	33.4
1.10	36.8	44.0	24.6	49.7	68.4	45.6	62.8	33.0
1.15	33.0	44.3	20.8	50.9	72.1	46.0	63.3	33.7
1.20	30.8	44.5	19.0	50.7	76.5	46.3	62.9	34.4
1.25	27.4	45.2	13.8	51.7	78.2	46.2	63.0	33.8
1.30	25.1	44.7	13.8	52.1	79.0	46.5	63.9	34.1
1.35	22.9	44.7	13.5	52.7	72.3	47.2	65.5	35.4
1.40	20.1	45.0	13.0	52.2	69.4	46.9	65.1	35.3
1.56	7.3	43.0	5.5	50.9	53.6	47.4	63.4	36.1
4TH PWR AVG	14.5	42.0	9.7	49.5	52.3	45.5	61.0	34.2

~~SECRET~~



VEHICLE 1174 TEMPERATURE DATA-ORBIT 101

ASCENDING NODE=ZERO PL TIME= 21660.0 SYSTEM TIME

PL TIME IN HRS.	CL-2	+28BU	21-5	21-7	21-6	2TC-2	SC-2	-28BU
0.05	57.8	28.2	45.6	50.0	41.4	39.2	46.2	28.0
0.10	56.9	28.1	46.5	50.4	41.9	39.4	46.8	28.0
0.15	56.6	28.2	46.5	49.2	42.4	39.5	45.1	28.0
0.20	55.2	28.2	46.7	50.4	42.8	39.1	46.1	28.0
0.25	55.7	28.2	46.4	49.6	42.9	39.0	45.5	28.0
0.30	54.6	28.2	46.4	49.7	42.7	38.5	44.2	28.0
0.35	54.1	28.2	45.9	49.2	42.8	38.3	44.5	28.0
0.40	52.5	28.2	45.4	49.1	42.0	38.1	43.7	28.0
0.45	52.4	28.2	45.1	48.6	41.7	38.6	43.3	28.0
0.50	51.7	28.2	44.5	47.9	41.7	36.9	42.7	28.0
0.55	51.3	28.2	43.2	47.4	42.1	36.5	42.1	27.9
0.60	50.7	28.2	44.1	47.5	42.4	37.3	41.7	28.0
0.65	52.1	28.2	43.5	48.2	41.4	36.5	42.0	28.0
0.70	52.1	28.1	43.6	48.2	40.7	37.1	41.6	28.0
0.75	43.8	28.2	42.8	41.6	35.8	38.9	36.1	28.0
0.80	52.9	28.2	44.2	48.3	40.4	37.3	40.9	28.0
0.85	66.0	28.2	43.2	47.8	42.7	36.9	46.6	28.1
0.90	54.2	28.1	43.3	48.3	40.6	37.7	40.8	28.0
0.95	54.5	28.2	43.8	48.3	40.4	37.2	41.7	28.0
1.00	54.9	28.2	44.2	48.7	41.0	37.5	41.6	28.0
1.05	55.4	28.2	44.4	49.2	40.7	38.2	42.7	28.0
1.10	56.1	28.1	45.2	49.3	40.7	37.6	43.1	28.0
1.15	56.8	28.2	45.2	49.6	40.8	38.6	43.3	28.0
1.20	57.9	28.2	45.1	50.4	41.5	38.4	43.9	28.0
1.25	57.5	28.1	46.4	50.4	41.3	38.5	44.4	28.0
1.30	57.7	28.2	46.6	50.6	41.9	39.2	45.2	28.0
1.35	59.6	28.2	46.9	50.1	41.8	39.5	45.1	28.0
1.40	59.0	28.2	47.6	50.2	41.9	39.3	45.5	28.0
1.56	57.8	28.2	45.6	50.0	41.4	39.2	46.2	28.0
4TH PWR AVG	55.2	28.2	45.1	49.0	41.5	38.3	43.7	28.0



~~SECRET~~

~~SECRET~~
~~SECRET~~

VEHICLE 1174 TEMPERATURE DATA-ORBIT 101

ASCENDING NODE=ZERO PL TIME= 21660.0 SYSTEM TIME

PL TIME IN HRS.	2S1-2	21-8	21-9	+28C1	21-10	+28C2	-28C1	21-12
0.05	42.9	50.7	43.6	28.4	48.0	28.6	4.1	49.6
0.10	42.9	50.8	43.7	28.5	48.6	28.5	4.1	49.7
0.15	42.9	51.2	44.6	28.5	48.6	28.7	4.1	50.4
0.20	41.4	51.2	43.9	28.6	48.0	28.7	4.1	49.5
0.25	40.6	50.8	44.5	28.4	48.3	28.6	4.1	48.8
0.30	41.2	50.7	44.6	28.5	47.7	28.6	4.1	48.5
0.35	40.1	50.1	44.5	28.5	47.4	28.6	4.1	47.7
0.40	38.5	49.2	43.1	28.4	46.7	28.6	4.1	47.0
0.45	39.7	49.2	43.5	28.5	46.3	28.6	4.1	46.4
0.50	38.0	48.4	42.8	28.5	45.7	28.4	4.1	45.2
0.55	40.2	47.8	41.7	28.4	45.5	28.4	4.1	44.9
0.60	39.7	47.5	42.2	28.4	46.8	28.6	4.1	44.5
0.65	41.4	47.5	41.5	28.4	47.3	28.6	4.1	44.6
0.70	42.3	47.0	41.0	28.4	47.8	28.5	4.1	44.7
0.75	42.2	46.9	36.5	31.0	48.5	28.3	4.1	44.8
0.80	41.8	47.2	42.0	28.7	48.6	28.6	4.1	45.3
0.85	63.9	46.4	42.0	28.4	48.8	28.6	4.1	46.7
0.90	43.4	47.4	42.4	28.6	49.8	28.6	4.1	45.8
0.95	44.8	47.2	42.7	28.4	50.0	28.5	4.1	47.6
1.00	43.9	47.8	43.6	28.5	50.4	28.6	4.1	48.4
1.05	44.5	48.4	43.6	28.6	51.2	28.7	4.1	49.6
1.10	45.8	48.5	44.4	28.5	50.9	28.5	4.1	50.1
1.15	45.0	48.9	44.7	28.4	50.7	28.6	4.1	51.3
1.20	45.3	49.7	44.7	28.4	51.4	28.5	4.1	52.1
1.25	44.3	49.7	45.8	28.5	50.1	28.5	4.1	52.3
1.30	42.7	50.4	45.5	28.4	50.8	28.6	4.1	52.0
1.35	44.8	51.7	46.2	28.5	51.0	28.6	4.1	52.6
1.40	44.1	51.9	45.7	28.4	50.5	28.6	4.1	52.5
1.56	42.9	50.7	43.6	28.4	48.0	28.6	4.1	49.6
4TH PWR AVG	43.1	49.2	43.4	28.6	48.7	28.6	4.1	48.4

~~SECRET~~
~~SECRET~~

~~SECRET~~
~~SECRET~~

VEHICLE 1174 TEMPERATURE DATA-ORBIT 101

ASCENDING NODE=ZERO PL TIME= 21660.0 SYSTEM TIME

PL TIME IN HRS.	ZBAT	21-13	-28C2
0.05	102.4	46.6	4.0
0.10	102.7	47.6	4.1
0.15	103.1	47.8	4.1
0.20	102.9	48.3	4.1
0.25	104.4	48.6	4.1
0.30	103.9	48.2	4.1
0.35	104.2	48.3	4.1
0.40	104.3	47.8	4.1
0.45	104.5	47.3	4.1
0.50	105.4	47.0	4.1
0.55	104.0	46.3	4.1
0.60	104.9	46.2	4.1
0.65	105.1	46.6	4.1
0.70	105.1	46.5	4.1
0.75	106.2	41.6	4.4
0.80	105.9	46.5	4.1
0.85	105.6	46.4	4.0
0.90	105.4	46.0	4.0
0.95	105.3	45.9	4.1
1.00	105.1	46.2	4.1
1.05	105.0	46.6	4.1
1.10	105.1	46.3	4.1
1.15	104.6	47.0	4.1
1.20	104.9	46.6	4.1
1.25	104.5	47.4	4.1
1.30	104.5	46.8	4.1
1.35	104.6	47.4	4.1
1.40	104.5	47.1	4.0
1.56	102.4	46.6	4.0

4TH PWR AVG 104.4 46.8 4.1

~~SECRET~~
~~SECRET~~

1004

LAUNCH REQUIREMENTS: The following Command Settings are specified for the
1174/J5 payload. Date of issue 1-30-64 (R-20) 2/6/64 (R-7)

COMMAND SELECTOR			VERIFICATION					
			PRIMARY			SECONDARY		
NO.	FUNCTION	POSITION	CH-LK-Pt	Volts	Tol	CH-LK-Pt	Volts	Tol
6	V/H Ramp Level	*8	11-01-02	2	± 0.1	8-02-24	2	± 0.1
			11-01-03	4	± 0.2	8-02-26	4	± 0.2
8	V/H Ramp Amplitude	*1	11-01-05	1	+0.05	8-02-28	1	+0.05
			11-01-06	1	+0.05	8-02-30	1	+0.05
9	Program	*5	11-01-08	2	± 0.1	8-02-32	2	± 0.1
			11-01-09	1	+0.05	8-02-34	1	+0.05
10	V/H Ramp Delay	*6	11-01-12	2	± 0.1	8-02-44	2	± 0.1
			11-01-13	2	± 0.1	8-02-45	2	± 0.1
11	Instrument Mode	*1	11-01-15	1	+0.05	8-02-48	1	+0.05
			11-01-16	1	+0.05	8-02-50	1	+0.05
12	Intermix Position	CV * 28	11-01-18	4	+ 0.2	8-02-52	4	+ 0.2
			11-01-19	4	+ 0.2	8-02-53	4	+ 0.2
15	Intermix Mode	*4	11-01-20	4	+ 0.2	8-02-55	4	+ 0.2

- * This information to be determined by R-5 day.
- * This information completed and/or revised 2/6/64.
(Commands settings and horizon optics settings)

~~SECRET~~
~~SECRET~~

~~SECRET~~

LAUNCH REQUIREMENTS: The following settings/requirements are specified for the
1174/J5 payload. Date of issue 1/30/64 (R-20) 2/6/64 (R-7).

PANORAMIC LENS SETTINGS:

	<u>Instrument No. 1 (Master)</u>	<u>Instrument No. 2 (Slave)</u>
Slit Dimensions	<u>0.250 X 2.278 In.</u>	<u>0.250 X 2.278 In.</u>
Filter Type	<u>Wratten 21</u>	<u>Wratten 21</u>

NOTE: SLIT LENGTH AND WIDTH MUST BE MEASURED AT TIME OF INSTALLATION

Measured by _____

Verified by _____

HORIZON OPTICS SETTINGS:

	<u>Instrument No. 1 (Master)</u>	<u>Instrument No. 2 (Slave)</u>
Supply Horizons:		
Aperture	<u>f6.8</u>	<u>*f6.0</u>
Speed	<u>1/100 Sec.</u>	<u>1/100 Sec.</u>
Filter	<u>Wratten 25</u>	<u>Wratten 25</u>
Take-up Horizons:		
Aperture	<u>*f6.0</u>	<u>f6.8</u>
Speed	<u>1/100 Sec.</u>	<u>1/100 Sec.</u>
Filter	<u>Wratten 25</u>	<u>Wratten 25</u>

STELLAR INDEX OPTICS SETTINGS:

	<u>Stellar Index A</u>	<u>Stellar Index F</u>
Stellar Lens:		
Aperture	<u>f1.9</u>	<u>f1.9</u>
Speed	<u>2.0 Sec.</u>	<u>2.0 Sec.</u>
Filter	<u>NONE</u>	<u>NONE</u>

~~SECRET~~

SECRET

LAUNCH REQUIREMENTS: CONTINUED Date of Issue 1-30-64 (R-20) 2/6/64 (P-1)
STELLAR INDEX OPTICS SETTINGS:

	<u>Stellar Index A</u>	<u>Stellar Index</u>
Index Lens:		
Aperture	<u>F4.5</u>	<u>F4.5</u>
Speed	<u>1/500 Sec.</u>	<u>1/500 Sec.</u>
Filter	<u>Wratten 21</u>	<u>Wratten 21</u>

FILM NOMENCLATURE:

~~Panoramic Instruments:~~

	<u>Instrument No. 1 (Master)</u>	<u>Instrument No. 2 (Slave)</u>
Primary:		
Type	<u>7J-40-16000</u>	<u>7J-40-16000</u>
Emul. Date	<u>45-73-12-3</u>	<u>45-73-12-3</u>
Wt. & Spool No.	<u>88.8-79.2-88-62B</u>	<u>88.5-79.0-88-45T</u>
Box No.	<u>50</u>	<u>50</u>
Secondary:		
Type	<u>7J-40-16000</u>	<u>7J-40-16000</u>
Emul. Date	<u>45-73-75-12-3</u>	<u>45-75-12-3</u>
Wt. & Spool No.	<u>88.4-78.9-88-77B</u>	<u>88.1-78.9-68-63T</u>
Box No.	<u>41</u>	<u>41</u>

PANORAMIC OFFSPOOLING REQUIREMENTS:

	<u>Master</u>	<u>Slave</u>
Original Length - Ft.	<u>16000</u>	<u>16000</u>
Length to Offspool - Ft.	<u>412</u> + 10	<u>412</u> + 10
Length to Load - Ft.	<u>15588</u>	<u>15588</u>

SECRET

LAUNCH REQUIREMENTS: CONTINUED Date of Issue 1-30-64 (R-20) 2/6/64 (R-7)

FILM NOMENCLATURE: CONTINUED

Stellar Index:

	Stellar Index A		Stellar Index B	
	Stellar	Index	Stellar	Index
Primary:				
Type	<u>3J-34-75</u>	<u>7J-33-135</u>	<u>3J-34-75</u>	<u>7J-33-135</u>
Emul. Date	<u>7-3-1-4</u>	<u>16-4-11-3</u>	<u>7-3-1-4</u>	<u>16-4-11-3</u>
Secondary:				
Type	<u>3J-34-75</u>	<u>7J-33-135</u>	<u>3J-34-75</u>	<u>7J-33-135</u>
Emul. Date	<u>7-3-1-4</u>	<u>16-4-11-3</u>	<u>7-3-1-4</u>	<u>16-4-11-3</u>

STELLAR INDEX FILM OFFSPOOLING REQUIREMENTS

	Stellar Index A		Stellar Index B	
	Stellar	Index	Stellar	Index
Original Length - Ft.	<u>75.0</u>	<u>135.0</u>	<u>75.0</u>	<u>135.0</u>
Length to Offspool - Ft	<u>32.6</u> ⁺⁰	<u>50.1</u> ⁺⁰	<u>34.1</u> ⁺⁰	<u>53.2</u> ⁺⁰
Length to Load - Ft.	<u>42.4</u>	<u>84.9</u>	<u>40.9</u>	<u>81.8</u>

CYCLE RATIO STELLAR INDEX TO PANORAMIC 1 to 7

STELLAR BAFFLE TYPE:

Stellar A	Stellar B
<u>11.500 In.</u>	<u>11.500 In.</u>
_____	_____
_____	_____

LAUNCH WINDOW: *

21:30 - 22:30

- cc: Flight Operations (2) _____ Date 1/30/64
- System Integration _____ Date 1-30-64
- System Engineering _____ Date 1-31-64
- Resident Officer _____ Date 1/31/64
- Buy Off Book _____ Date _____
- System Log _____ Date 30/Jan 64

~~SECRET~~
~~SECRET~~



LAUNCH REQUIREMENTS VEHICLE 1174

Attached is the Launch Requirements and limitations for Vehicle
1174/S-5



Chief System Engineer



cc:

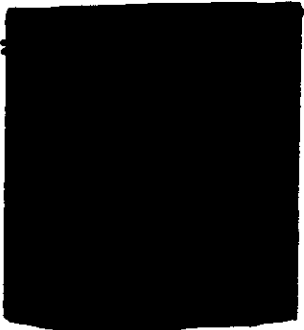

~~SECRET~~
~~SECRET~~



1.0 SCOPE

1.1 General

The following requirements govern the condition under which the vehicle will be launched with the A/P Payload System. Any deviation from the prescribed limits shall be cause for hold. Any status changes must be reported to System Integration immediately after occurrence for evaluation. All discrepancies and deviations must be corrected prior to resumption of vehicle launch count-down.

2.0 Payload Internal Temperature

65 ± 10° F from mating to T-4 hours.

65 ± 5° F from T-4 hours thru launch.

Temperature on Payload System shall be monitored every one-half hour from mating to launch.

3.0 Relative Humidity

50% or less at all times.

4.0 N₂ Pressure

The N₂ must be connected and flowing when the system is on the launch pad. Maximum off time is ½ hour per day.

5.0 SRV Transmission Frequency

Recovery T/M 228.2 ± 0.1 MC

Recovery Beacon 235.0 ± 0.1 MC

6.0 Power

Power must be applied to the payload interface whenever the Payload is raised or lowered.

7.0 Thermal Blanket

The thermal blanket must remain on the Payload from mating until launch.

~~SECRET~~
~~SECRET~~

8.0 Primary TLM Readouts

Payload checkout (must be verified thru vehicle TLM)

8.1 Lens Rotation, Horizon idler, and center of format Instrument No. 1 channel 09 Link I. No back-up channel is available.

8.2 Lens Rotation, Horizon idler, and center of format Instrument No. 2 channel 10 Link I. No back-up channel is available.

8.3 Ring A Commutator (1 x 60) channel 11 Link and points listed below.

The primary commutated points must be verified during Payload task and task 16.

MONITOR Function	VERIFICATION					
	PRIMARY			ALTERNATE		
	CH-LK-PT	Volts	Tol.	CH-LK-PT	Volts	Tol.
Inst. 1 Cycle Count 1	11-1-22	.55 step	+ .15 -	11-1-25	.9 or less	.9 or less
Inst. 1 Cycle Count 10	11-1-23	.55 step	" .15	11-1-25	"	"
Inst. 1 Cycle Count 100	11-1-24	.55 step	" .15	11-1-25	"	"
Film Footage Pot Inst. 1	11-1-25	.9 or less	.9 or less	8-2-56	"	"
Inst. 2 Cycle Count 1	11-1-27	.55 step	+ .15 -	11-1-31	"	"
Inst. 2 Cycle Count 10	11-1-28	.55 step	" .15	11-1-31	"	"
Inst. 2 Cycle Count 100	11-1-29	.55 step	" .15	11-1-31	"	"
Calibrate Plus	11-1-30	5	--	11-1-07	5	--
Calibrate Plus	11-1-30	5	--	11-1-14	5	--
Inst. 2 Film Footage Pot	11-1-31	.9 or less	.9 or less	8-2-47	.9 or less	.9 or less
Inst. 1 Door Eject	11-1-35	1.3	+ .2 -	None	--	--
Inst. 2 Door Eject	11-1-45	1.3	" .2	"	--	--
Film Door Closure	11-1-47	4.7	" .2	"	--	--
Fairing Separation	11-1-49	1.3	" .2	"	--	--
Continuity Loop SRV-1	11-1-51	5.38	" .2	"	--	--
Separation Monitor	11-1-52	0.3	+ .2 - .1	16-1-25	0.3	+ .2 - .1
Recovery Battery SRV-1	11-1-53	0	+ .2 -	None	--	--
Continuity Loop SRV-2	11-1-54	5.38	" .2	"	--	--
Recovery Battery SRV-2	11-1-55	0	" .2	"	--	--
Calibrate Zero	11-1-57	0	--	11-1-04	0	--
Calibrate Zero	11-1-57	0	--	11-1-11	0	--
Calibrate Zero	11-1-57	0	--	11-1-17	0	--
Sync	11-1-58	5.5	+ .2 -	11-1-59	5.5	+ .2 -
Sync	11-1-58	5.5	" .2	11-1-60	5.5	" .2

All Command Selector points as listed per launch requirements 14 in appendix - I.

9.0 Homing of Camera Stoves

9.1 Both camera stoves must be properly homed prior to terminal count.

10.0 Launch Requirements Command Settings

10.1 All stepping switches must be positioned in accordance with the Command Settings List prior to terminal count. (See attached)

11.0 Film Consumption Prior to Launch

11.1 Minimum film consumption prior to launch shall be 100 cycles on both Instruments.

11.2 Should the Payload System stay on the pad for an extended period, the System shall be operated 10 cycles per applicable procedure every other day.

12.0 Responsibility

12.1 It shall be the responsibility of the senior A/P Payload Engineer to ensure the implementation of the restrictions and requirements listed herein. In addition, he is charged with the responsibility of supplying the following System information immediately prior to launch to Flight Operations and Computer Services by telephone:

12.1.1 Final System weight, in lbs. _____

12.1.2 Cycle counter and film footage pot readings for both Instruments, prior to loading, in units and volts respectively.

	Cycle Counter	Film Footage Pot
a. Master	_____	_____
b. Slave	_____	_____

12.1.3 Cycle counter and film footage pot readings for both Instruments, at launch, in units.

	Cycle Counter	Film Footage Pot
a. Master	_____	_____
b. Slave	_____	_____

12.1.4 Clock error, static run, in microseconds. _____

12.1.5 Length of off-spool of both Instruments, in feet.

a. Master	_____
b. Slave	_____

12.1.6 Length of off-spool of both S/I Instruments in feet.

a. S.I. A Stellar	_____
Index	_____
b. S.I. B Stellar	_____
Index	_____